

Your
CORVETTE
OPERATIONS MANUAL

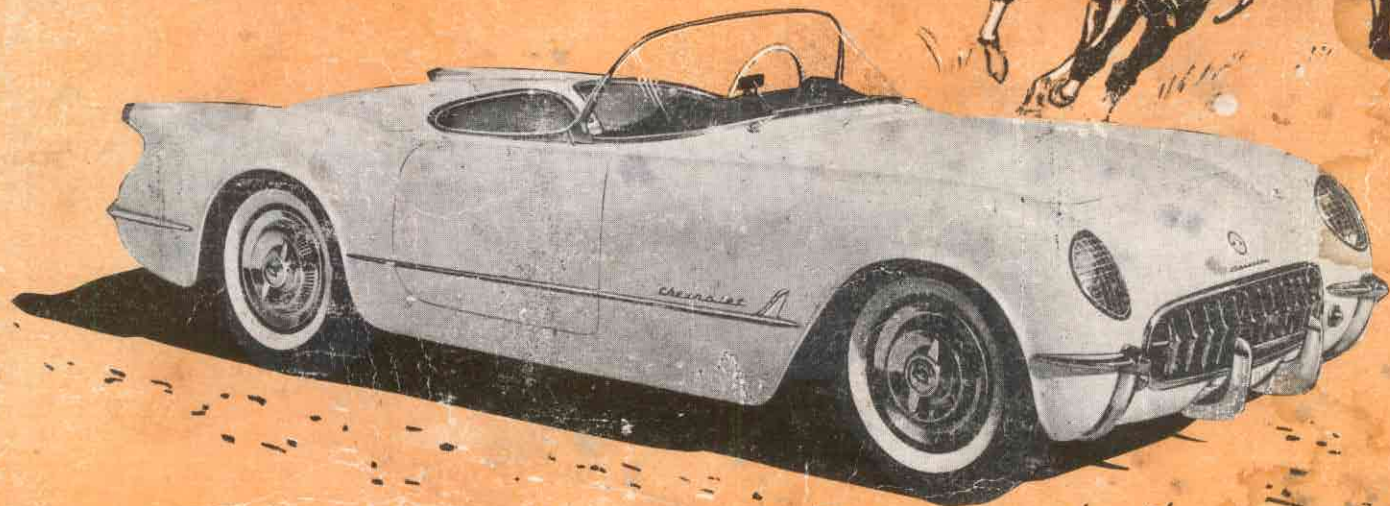

Welcome to the large and happy family of Chevrolet owners!

A warm welcome to a new form of motoring pleasure is extended to you as a Corvette owner. This is your introduction to an all new and distinctive design in which Chevrolet combines many of the desirable features of the passenger car into a truly fine and beautiful sports car.

This manual has been prepared to provide you with necessary information on features, driving, care and maintenance of your new Corvette. Read the information contained herein carefully and keep it as a handy reference. Your Chevrolet dealer, who is equipped to perform complete maintenance on the Corvette, will be glad to assist you in any problems concerning the operation and servicing of your car. Do not hesitate to consult him.

All information, illustrations and specifications contained in this literature are based on the latest product information available at the time of publication approval. The right is reserved to make changes at any time without notice.

A GUIDE TO THE IMPORTANT FEATURES OF YOUR NEW CORVETTE

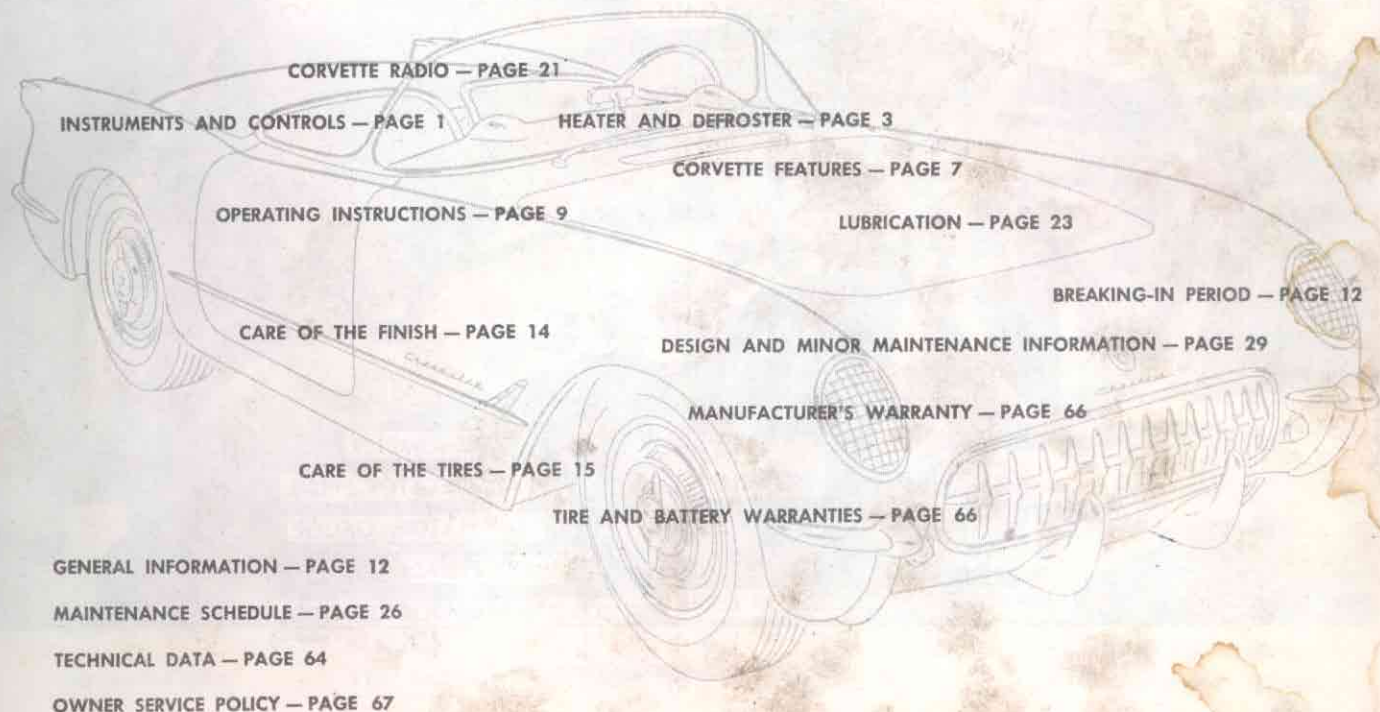

CORVETTE RADIO — PAGE 21

INSTRUMENTS AND CONTROLS — PAGE 1

HEATER AND DEFROSTER — PAGE 3

CORVETTE FEATURES — PAGE 7

OPERATING INSTRUCTIONS — PAGE 9

LUBRICATION — PAGE 23

CARE OF THE FINISH — PAGE 14

BREAKING-IN PERIOD — PAGE 12

DESIGN AND MINOR MAINTENANCE INFORMATION — PAGE 29

CARE OF THE TIRES — PAGE 15

MANUFACTURER'S WARRANTY — PAGE 66

TIRE AND BATTERY WARRANTIES — PAGE 66

GENERAL INFORMATION — PAGE 12

MAINTENANCE SCHEDULE — PAGE 26

TECHNICAL DATA — PAGE 64

OWNER SERVICE POLICY — PAGE 67

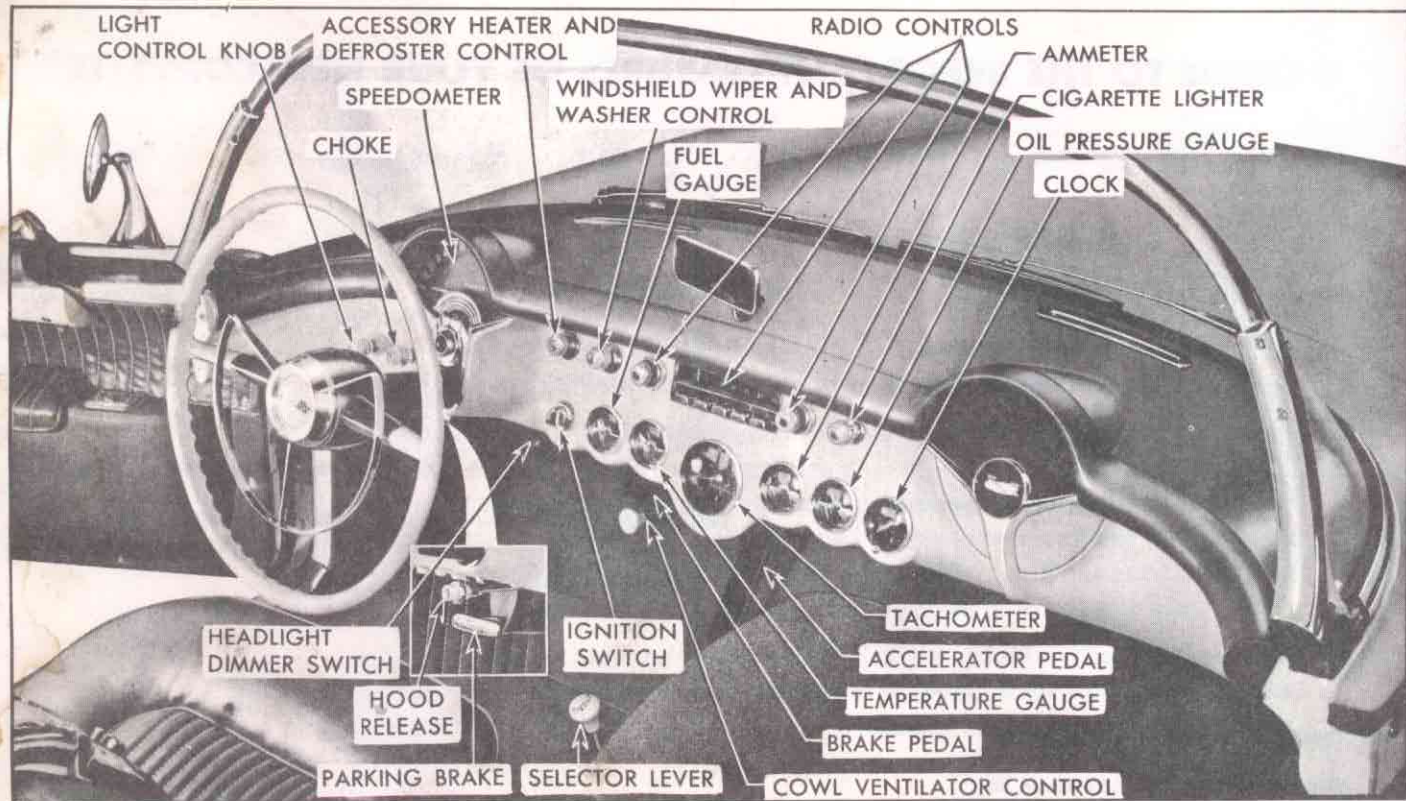

Fig. 1—Instruments and Controls

INSTRUMENTS AND CONTROLS

SPEEDOMETER

The speedometer located on the instrument panel above the steering column (fig. 2) registers both speed and accumulated mileage. A hood over the upper portion of the speedometer reduces reflections during night driving.

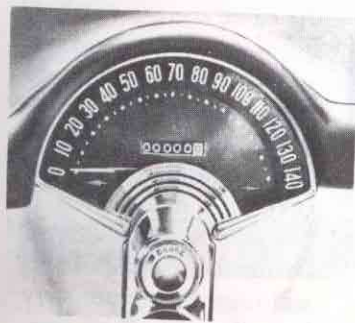

Fig. 2—Speedometer and Parking Brake Alarm

FUEL GAUGE

The fuel gauge (fig. 3) is operated electrically to indicate the amount of fuel in the 17 gallon fuel tank with the ignition switch turned on. When the ignition is turned off, the pointer returns to the empty mark.



Fig. 3—Fuel Gauge

TEMPERATURE GAUGE

The temperature gauge



Fig. 4—Temperature Gauge

(fig. 4) shows engine coolant temperature in the cylinder head. Temperature indications will vary with thermostat range, outside air temperature and operating conditions of the vehicle. Long hard drives or prolonged idling in very hot weather may produce above normal temperature indications.

TACHOMETER

The tachometer located in the lower center of the instrument panel (fig. 5) indicates the speed of the engine in revolutions per minute. Incorporated into the tachometer is a revolution counter which indicates the cumulative total of engine revolutions.



Fig. 5—Tachometer

AMMETER

The ammeter (fig. 6) shows the rate at which the battery is being charged or discharged. The generator is equipped with a regulator which controls the charge according to battery requirements. When the generator is supplying more than the current demand, the ammeter will show the charging rate, while a discharge will be shown if the demand of the equipment switched on is greater than the generator output. When battery is fully charged, the charging rate will be low, thus giving an indication of the condition of the battery.

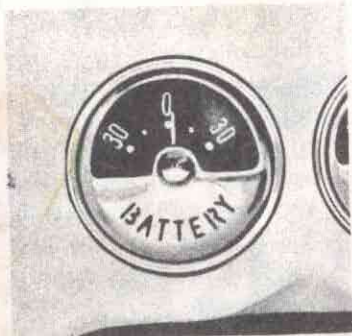

Fig. 6—Ammeter

OIL PRESSURE GAUGE

The oil pressure gauge (fig. 7) is installed primarily as an indicator to show whether or not the oil pump is working and does not necessarily indicate the condition or quantity of oil in the crankcase. The oil pressure gauge should always indicate pressure when the engine is running. If no pressure

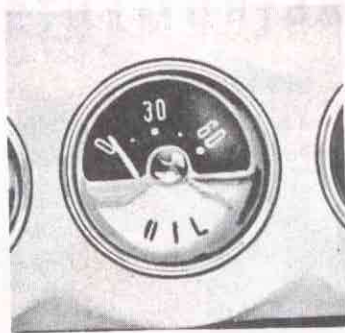

Fig. 7—Oil Pressure Gauge

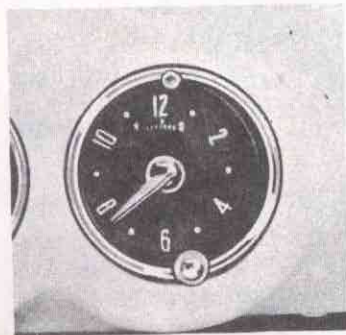

Fig. 8—Clock

is indicated, stop the engine immediately and have the cause corrected. When starting a cold engine, it will be noted that the oil pressure gauge will register a high oil pressure. As the engine warms up, the pressure will drop until it reaches a point where changes to higher speeds will raise the pressure very little if at all. If oil pressure registers abnormally high after the engine is thoroughly warmed up, it may indicate the possibility of plugged oil lines and passages and should be inspected to determine the cause.

CLOCK

An illuminated electric clock (fig. 8) is located to the right of the oil pressure gauge. The clock is set by pulling out and turning the knob at the bottom of the dial.

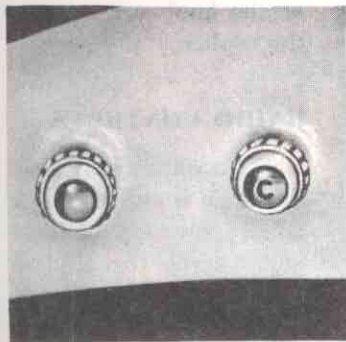

Fig. 9—Light and Choke Controls

LIGHT CONTROL KNOB

The light control knob (fig. 9) is located at the extreme left of the lower instrument panel and controls a two position push-pull switch. Pull knob to first position for parking, tail, license and instrument panel lights. In the second position, headlight beams replace parking lights. Instrument

panel lights may be regulated by rotating the knob.

CHOKE

The choke, located adjacent to the light control knob (fig. 9), is used to provide a richer fuel mixture to assist in starting a cold engine. Pull choke knob out part way or all the way depending upon climatic conditions. This automatically opens the throttle to provide for smooth engine operation when choking is required.

CAUTION: Excessive use of the choke will provide a fuel mixture too rich to burn. Some of this unburned fuel will leak past the pistons and dilute the engine oil, resulting in improper

lubrication, excessive engine wear and poor performance. When it is necessary to use the choke for starting, it should be pushed part way in as soon as the engine starts and all the way in as soon as the engine will run smoothly without its use.

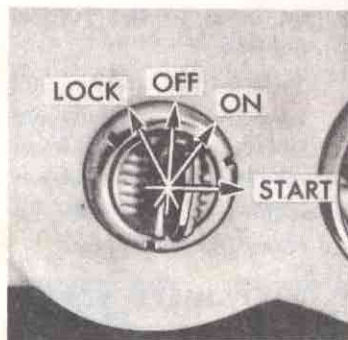

Fig. 10—Key Starter and Ignition Switch

KEY STARTER AND IGNITION SWITCH

The four positions of the key starter (fig. 10) are: LOCK, OFF, ON and START. To operate, turn switch to START. As soon as the engine starts, release switch, which will return to ON position. The key is required only when turning to or from LOCK position.

HEATER AND DEFROSTER CONTROL

The Corvette recirculating heater and defroster, which is available as a factory installed optional accessory, has a single control knob (fig. 11) located above the ignition switch and adjacent to the speedometer.

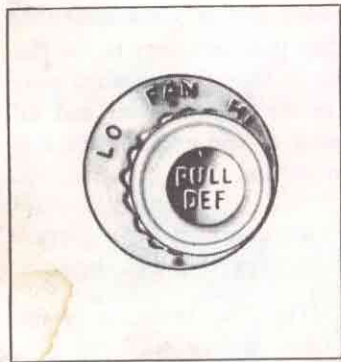

Fig. 11—Heater and Defroster Control

The warm air is divided between the heater and defroster in proportion to the amount of control knob pull-out.

WINDSHIELD WIPER AND WASHER CONTROL

With the engine running, the windshield wiper and washer control knob (fig. 12) may be rotated to regulate wiper action, while pressing and then releasing the button in the center

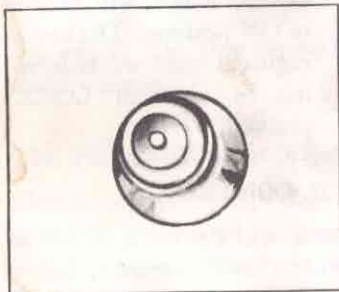

Fig. 12—Windshield Wiper and Washer Control

To control the heater, push knob fully "In" and rotate to desired "LO" or "HI" blower operation. Warm air from heater is deflected down towards the floor. To turn off rotate index mark on knob to the vertical position.

To operate defroster, pull knob out or partially out and rotate to desired blower velocity as described above.

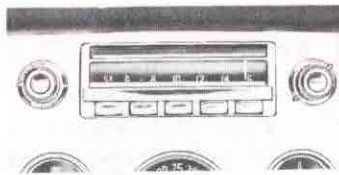

Fig. 13—Radio Controls

The Corvette signal seeking radio is available as a factory installed optional accessory. When installed, the radio controls (fig. 13) are located in the upper center of the instrument panel and consist of left and right inner and outer control knobs, push button controls, a favorite station selector, and an automatic tuning bar. A complete description of the operation of the Corvette radio is contained on pages 21 and 22.

CIGARETTE LIGHTER

The cigarette lighter (fig. 14) is located on the upper face of the instrument panel above the oil pressure gauge and is operated by pushing in and releasing. When heated, it automatically clicks out for use.

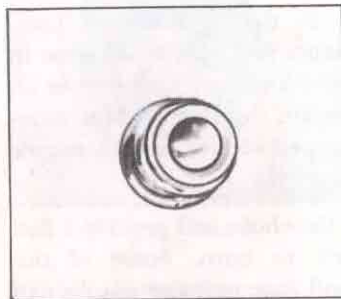

Fig. 14—Cigarette Lighter

of the knob will operate the washer.

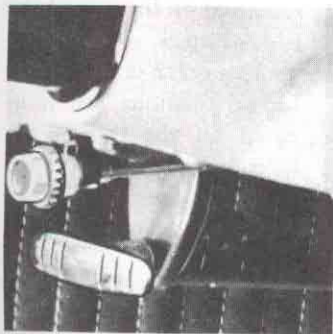

Fig. 15—Parking Brake and Hood Lock Controls

with ignition switch on to indicate by means of a flashing red light when the parking brake is applied.

HOOD LOCK CONTROL

The hood lock is released by pulling out the control knob located under the left side of the instrument panel, near the parking brake T-handle (fig. 15). This releases the hood to enable it to be raised manually to the open position. The hood is hinged at its forward end to supports at the sides of the radiator. A telescoping hood support, which locks when the hood reaches the open position, is provided. To lower the hood, it must first be raised to disengage the hold-open support and then lowered fully to engage the hood lock.

PARKING BRAKE AND ALARM LIGHT

The parking brake operates independently of the service brakes and is applied by pulling straight back on the T-handle (fig. 15). To release, simply turn the handle slightly and push in to normal position. A parking brake alarm light, located below the speedometer (fig. 2), operates only

DIRECTION SIGNAL

The direction signal lever is located on the left side of the steering column forward of the steering wheel. Moving this lever downward for a left turn and upward for a right turn will impart a flashing signal through the parking and stop lights to indicate direction of turn. The lever will automatically return to the "off" position upon completion of turn. The signal direction is indicated to the driver by a flashing arrow in the speedometer.

HORN RING

A horn ring is provided on the steering wheel to control the operation of the horn. Finger tip pressure at any point on this ring will provide the electrical contact necessary to blow the horns.

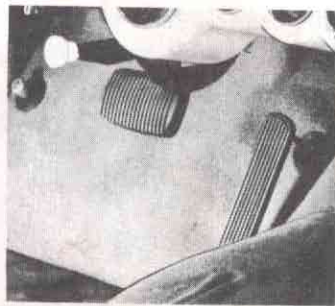

Fig. 16—Cowl Ventilator and Foot Controls

COWL VENTILATOR CONTROL

The cowl ventilator is opened and closed by means of the control handle located below the instrument panel (fig. 16). A ratchet mechanism provides several positions for the regulation of the air admitted.

HEADLIGHT DIMMER SWITCH

Beam selection for high or low headlight beams may be made by exerting foot pressure on the dimmer switch located at the left side of the floor toe board (fig. 16). A headlamp beam indicator is provided in the speedometer and a small opening beneath the 70 mile mark is illuminated when the high beams are on.

BRAKE PEDAL

Depressing the foot operated pendant type brake pedal (fig. 16), which is supported from the master cylinder attached to the dash panel, applies the hydraulic service brakes at all four wheels in proportion to the pressure applied on the pedal.

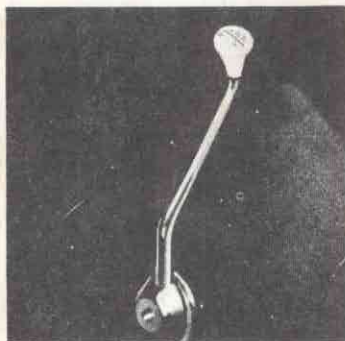

Fig. 17—Powerglide Selector Lever

ACCELERATOR

The accelerator pedal (fig. 16) controls engine speed and is designed to provide the proper "feel", neither too light nor too firm, for smooth control.

POWERGLIDE SELECTOR LEVER

The selector lever for the transmission (fig. 17) is

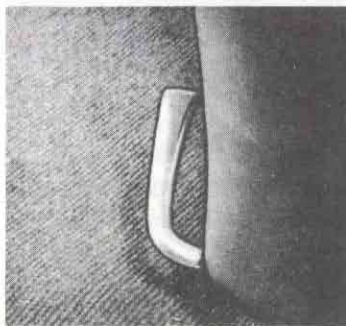

Fig. 18—Seat Adjuster Control Lever

front of driver's seat frame near the left corner (fig. 18), and when pulled upward allows the seat to be

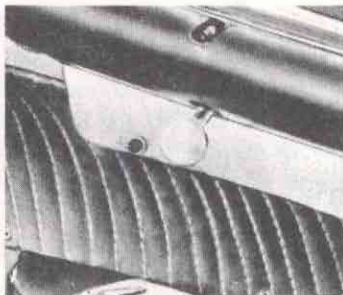

Fig. 19—Door Lock Inside Handle

mounted on the side of the floor tunnel within convenient reach of the driver. Lever positions are indicated on the top of the lever knob. More detailed information on selector lever positions can be found on page 9.

SEAT ADJUSTER

The seat adjuster control lever is located on the front of driver's seat frame near the left corner (fig. 18), and when pulled upward allows the seat to be adjusted forward or backward.

DOOR LOCK INSIDE HANDLE

To open the door, the lock is released from either inside or outside the car by grasping the ball handle at the front of the door inner panel (fig. 19) and pulling rearward.

CORVETTE FEATURES

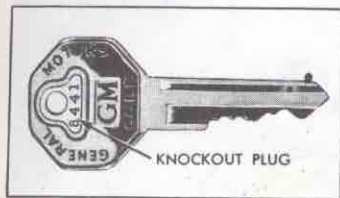

Fig. 20—Key

The number stamped on the key should be removed so that unauthorized persons cannot obtain the key number and have a duplicate made.

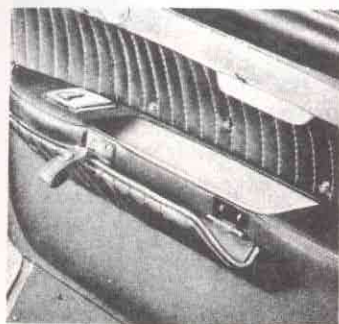

Fig. 21—Package Compartment and Ash Tray

An ash tray is provided in each door forward of the package compartment. To empty, lift ash tray and remove.

KEYS AND LOCKS

A single key operates both the ignition switch and luggage compartment lid lock. Record the key number upon delivery of the car. The “knockout” plug (fig. 20) upon which the number is stamped should be removed so that unauthorized persons cannot obtain the key number and have a duplicate made.

PACKAGE COMPARTMENTS

A package compartment is provided in the interior paneling of each door. The compartment has a hinged cover that may be easily lifted with a footman strap.

ASH TRAY

An ash tray is provided in each door forward of the package compartment. To empty, lift ash tray and remove.

FOLDING TOP COMPARTMENT

The folding top, when lowered, is stowed in a compartment behind the driver and passenger seats. A hinged lid, which is secured by a push button lock between the seat backs covers the top compartment and also serves to anchor the rear of the top, when raised, by means of two bushings in the lid, into which are inserted the ratchet-type spring loaded clamps on the top rear bow. See pages 17-19 for folding top operating instructions.

DOOR VENTILATOR AND WINDOW

For protection against inclement weather, attachable plexi-glass side window and ventipane assemblies (fig. 22), are provided which may be quickly and easily installed

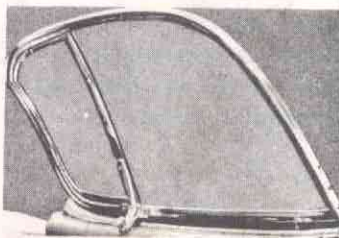

Fig. 22—Door Ventilator and Window

to or removed from each door. The ventipanes are friction type and without handles, requiring direct hand pressure for opening and closing. When not in use the side windows are stored in the luggage compartment. For installation instructions, see page 16.

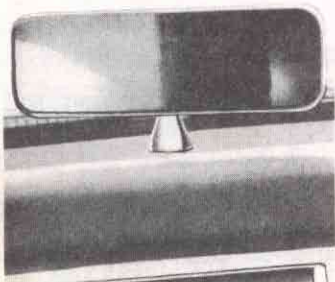

Fig. 23—Rear View Mirror

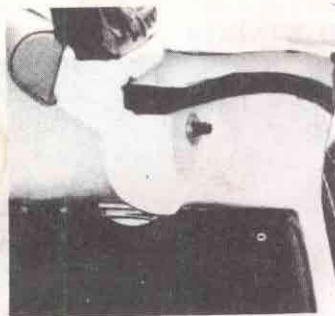

Fig. 24—Courtesy Lamp

A spacious luggage storage area is provided at the rear of the body (fig. 25). Access to this storage area, as well as to

REAR VIEW MIRRORS

Two rear view mirrors, one mounted on the top center of the instrument panel (fig. 23) and the other mounted on the left door outer panel are adjustable to accommodate all driving positions.

COURTESY LAMPS

Courtesy lamps are located under the bottom flange of the instrument panel near each end of the panel (fig. 24). These lamps illuminate the floor area and are automatically lighted by means of a switch on the body pillar when either door is opened.

LUGGAGE COMPARTMENT

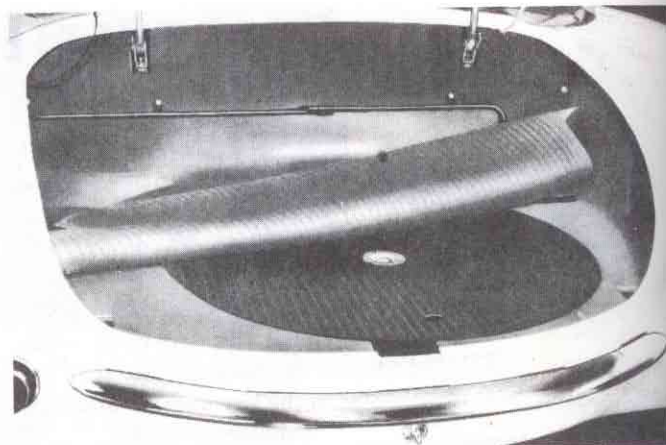

Fig. 25—Luggage Compartment

the spare tire stowed beneath the luggage compartment floor is gained by inserting the key into the lock below the rear bumper and turning until the lid is released from the lock. Then insert fingers under lid edge and raise to open position. The lid hinges are spring loaded for ease in opening and counterbalanced to remain in the open position without support.

NOTE: The wheel wrench, scissors jack and handle, which are provided as tools, as well as the door window and ventilator assemblies, are stored in the luggage compartment when not in use.

OPERATING INSTRUCTIONS



Fig. 26—Selector Lever Positions

POWERGLIDE SELECTOR LEVER POSITIONS

Control of the Powerglide transmission is provided by five different positions of a selector lever which is mounted on the side of the floor tunnel within convenient reach of the driver. The lever positions, which are described below, are

indicated on top of the selector lever knob (fig. 26).

- R — REVERSE** For backing up. Bring car to a complete stop before selecting this position.
- L — LOW** Use only when pulling through deep snow or sand, climbing or descending very steep hills, and for additional engine braking below 40 M.P.H.
- D — DRIVE** For all normal driving. Transmission automatically selects the range best suited to every driving situation.

- N — NEUTRAL** Allows engine to be operated with car standing still.
- P — PARK** Holds the car immovable, even on steep grades.

STARTING THE ENGINE

Remember, carbon monoxide is a poisonous gas. Never start or run the engine in a closed garage.

1. The engine can be started in either "P" or "N" position. The starter is inoperative in any other position, since a safety switch is provided to prevent starting the engine with the transmission in gear. If engine is very cold or car is on hill, "P" position is preferable.
2. Pull choke knob out part way or all the way depending on climatic conditions. If the engine is warm or in summer weather, it is not generally necessary to use the choke at all. In extremely cold weather the choke should be pulled all the way out.
3. Hold accelerator pedal down halfway and turn key starter to START (fig. 10). Release as soon as engine starts. Key starter will automatically return to ON.

NOTE: Do not pump the accelerator pedal before or during the use of the starter as this will cause difficult starting.

4. As soon as the engine starts, push the choke knob in part way until engine idles smoothly. After engine has warmed up, push choke knob in all the way.

NOTE: When starting a cold engine, it will be noted that the oil pressure gauge will register a high pressure. Do not accelerate the engine excessively until the oil is sufficiently warm to permit a lower pressure. If the gauge does not show any pressure, stop the engine immediately and determine the cause.

5. In case the engine becomes overchoked or flooded at any time, be sure the choke button is all the way in, then press the foot accelerator down fully and operate starter continuously until engine starts. This will eliminate further choking. If it becomes desirable or necessary to again choke the carburetor for starting, follow the procedure in steps 2-5.

NOTE: Excessive use of the choke will provide a fuel mixture too rich to burn. Some of this unburned fuel will leak past the pistons and dilute the engine oil, resulting in improper lubrication, excessive engine wear and poor performance.

DRIVING WITH POWERGLIDE

Place the selector lever in **D** and press the accelerator for smooth, effortless driving in city or country. Powerglide

automatically selects the range most suited to your driving needs. Starting, the car moves forward in automatic low, changing to cruising range between 10 and 52 M.P.H. depending on accelerator position. While cruising at speeds below 48 M.P.H., Powerglide will change automatically to low range when accelerator is fully depressed for maximum acceleration. At low speeds above 10 M.P.H., this change may occur before accelerator is fully depressed. As the car slows to a stop, Powerglide changes to low range at 9 M.P.H. in readiness for the next start.

NOTE: The above road speeds are approximate and may vary with individual cars.

L position should be used when climbing very steep grades at reduced speed, or when pulling through deep sand and snow. At speeds below 40 M.P.H. this range may be used to provide additional engine braking for descending steep grades or slowing down on slippery pavement.

R position reverses Powerglide for backing. Bring car to a complete stop and move selector lever to **R** position with engine idling.

Remember that Powerglide is completely automatic. Simply move the selector lever to the desired position and press accelerator to go. Do not attempt to force a change from low to cruising range by releasing the accelerator. In wide open acceleration, Powerglide will change from low to

cruising range at 52 M.P.H. During moderate acceleration, this change may occur as low as 10 M.P.H. Because Powerglide automatically selects the range best suited to any driving condition, maximum performance and economy is assured.

DRIVING CAUTIONS

A few driving cautions should be observed:

- Do not accelerate engine for over ten seconds in **D**, **L**, or **R** when car is held with brakes.
- When stopped on an upgrade, do not hold car by accelerating engine except very briefly. Use service brake.
- Move selector lever to **L** for extremely hard pulls at low road speed.
- Do not move selector from **D** to **L** at speeds over 40 M.P.H.
- Never move selector to **R** when car is moving forward.
- Engage parking **P** only when car is completely stopped.

TOWING AND PUSHING CAUTIONS

- Pushing the Corvette is not recommended.
- If your Corvette must be towed, place selector lever in **N**. Do not exceed 48 M.P.H. If the transmission is not operating properly, the propeller shaft should be disconnected from the rear axle or the rear wheels raised before any towing is attempted.
- Should it ever be necessary to start the engine by towing the car, place the selector lever in **N** until the car reaches a minimum speed of 15 M.P.H. on a dry surface or 20 M.P.H. on a slippery road. Turn key starter to **ON** and move selector to **L**. When engine starts, move selector to **D**.

NOTE: Use extreme care to prevent car from accelerating into tow car when engine starts. Avoid using too short a tow line to minimize this possibility.

- Using the Corvette to push or pull other vehicles is not recommended.

BREAKING-IN PERIOD

To maintain the high standard of performance and efficiency of your Corvette, special attention should be given for the first two thousand miles to lubrication and the speed at which the car is driven. The crankcase of the engine is filled with a light body "breaking-in" oil. **USE THIS OIL ONLY DURING THE FIRST 500 MILES OF DRIVING.**

Check the oil frequently during the first 500 miles. At the end of 500 miles, drain the crankcase while hot and refill

with the grade of oil recommended on page 23. Check oil level each time gas is purchased and change at recommended drain periods.

To break-in the moving parts of the engine properly, do not drive faster than:

40 miles per hour for the first 100 miles.

50 miles per hour for the next 200 miles.

60 miles per hour for the next 200 miles.

GENERAL INFORMATION

GASOLINE AND ENGINE OIL

The engine is designed to deliver maximum performance with "Premium" grades of gasoline. Use of the proper engine oil is also of great importance in assuring maximum performance and economy. See recommendations on pages 23 and 26.

GASOLINE FILLER CAP

The gasoline filler cap is located under the lid in the left rear fender to the rear of the door opening (fig. 27). This cap is designed with a built-in spring loaded



Fig. 27—Gasoline Filler Cap

valve to prevent pressure build-up and surging of gasoline out of the tank on turns.

COOLING SYSTEM FILLER CAP

A pressure type radiator auxiliary tank filler cap is provided on the top rear



Fig. 28—Engine Oil and Cooling System Filler Caps

portion of the rocker cover (fig. 28) and is rotated to the left to remove.

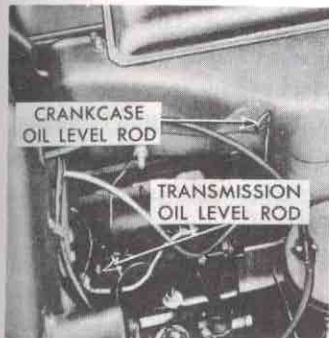

Fig. 29—Oil Level Rod Locations

portion of the auxiliary tank located on the right side of the engine. When removing, rotate left to first stop to relieve pressure in system, then turn cap again to remove.

ENGINE OIL FILLER CAP

The oil filler cap for the engine lubrication system is located at the top front portion of the rocker cover (fig. 28) and is rotated to the left to remove.

ENGINE OIL LEVEL ROD

The engine oil level rod, located on the right side of the crankcase (fig. 29) is marked FULL and ADD OIL. Check oil frequently and maintain level between these two lines. Avoid overfilling.

TRANSMISSION OIL LEVEL ROD

The Powerglide transmission oil level rod on the right side of the engine (fig. 29) is marked FULL and ADD 1 QT. Check every 1000 miles with transmission in Neutral, engine warm and idling. Avoid overfilling.

USE OF THE JACK

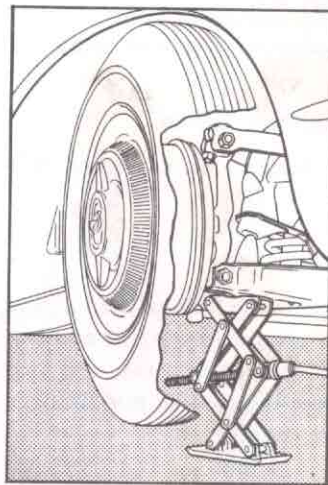

Fig. 30—Position of Jack for Front Tire Change

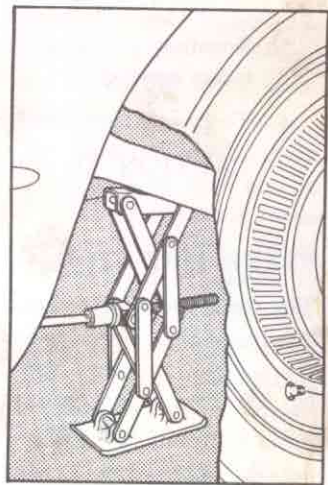

Fig. 31—Position of Jack for Rear Tire Change

1. Set parking brake, move selector lever to park position, and block diagonally opposite wheel.

2. To remove wheels, position jack on the ground under car at following locations:
 - a. At front wheel place jack under the front suspension lower control arm near outer end (fig. 30).
 - b. At rear wheel place jack under rear axle housing near rebound strap (fig. 31).
3. Rotating jack handle clockwise, raise car until tire clears ground.
4. To lower, turn handle counterclockwise.

CAUTION: Do not get underneath car when it is on jack.

SPARE TIRE STORAGE

The spare tire is stowed in a well in the floor of the luggage compartment. A plywood cover retained by a bolt and stationary nut, overlaps the floor surrounding the well (see fig. 25). To gain access to the tire, lift up floor mat, remove cover retaining bolt and remove cover.

CARE OF THE FINISH

To preserve the original beauty and value of the Duco finish, keep it as clean as possible. When washing the car, always use clear cold water. Never wash in the direct rays

of the sun. Maintain the original gloss by application of a mild liquid polish. Abrasive polishes and cleaners may do the job quicker, but may also remove some of the good finish.

All chrome parts can best be maintained by frequent washing and occasional waxing. The wax used for polishing cars is very satisfactory. To apply, first wash with water, then dry with a chamois and apply wax with a clean soft cloth. Finish by polishing with another cloth.

For chrome plated surfaces already damaged by rust clean with a cleaning compound which your dealer can supply and then apply a protective wax coating.

CARE OF THE COOLING SYSTEM

The cooling system should be kept clean. The use of a rust inhibitor in the cooling system when plain water is used as a coolant will materially aid in keeping the system clean. Also use only rust-inhibiting anti-freeze solution, following the manufacturer's specifications. To insure uniform distribution of the anti-freeze throughout the cooling system, it is recommended that the anti-freeze be mixed to proper proportions before adding to the system through the auxiliary tank. The vapor line connecting the radiator auxiliary tank with the top of the radiator should be checked regularly to see that it does not bend or sag between ends and

accumulate a pocket of water or vapor that would prevent a transfer of air.

To drain the cooling system, open drains at the bottom of the radiator and lower left rear side of engine block.

CARE OF THE TIRES

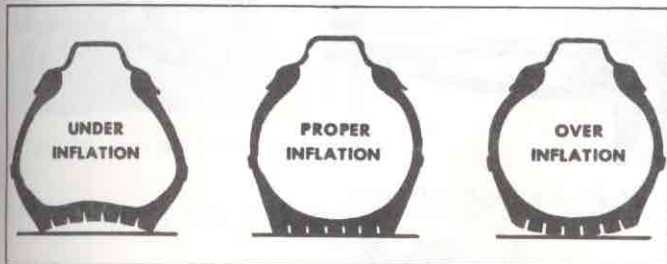

Fig. 32—Tire Inflation

Under Inflation	Proper Inflation	Over Inflation
Runs Hot	Good Ride	Hard Ride
Loosens Cords	Good Traction	Poor Traction
Uneven Wear	Even Wear	Bruises
Blowouts	More Mileage	Fabric Breaks

To enjoy maximum service from your tires—maintain these recommended pressures during normal operation of your Corvette:

Starting Pressure—22 lbs. when car has been standing three hours or driven less than a mile.

City Pressure —25 lbs. after driving a car three miles or more below 40 miles per hour.

Highway Pressure—27 lbs. after driving car three miles or more above 40 miles per hour.

For sustained high speed operation of your Corvette, maintain front and rear starting pressure of 28 lbs.

Hard driving normally increases tire pressures. Do not “bleed” tires to reduce this higher pressure. Valve caps should always be installed and tightened firmly to prevent dust and water from entering and damaging valve seats. The caps also act as an air seal.

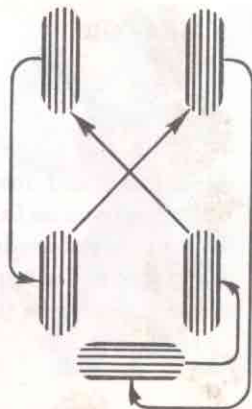

Fig. 33—Tire Rotation Diagram

To help prevent uneven wear of front tires and to distribute wear evenly over all five tires, they should be changed as shown in Fig. 33 every 5,000 miles. Your Corvette is equipped with 6.70x15—4 ply rating white-wall tires which should be maintained at the above recommended pressures for maximum service. It is intended that these tires be used only for normal operation of your

car such as experienced in average passenger car usage. For reasons of safety, it is recommended that these tires not be used for extreme vehicle operation such as racing.

NOTE: The simulated knock-off type of hub caps installed on Corvette wheels are to be removed by prying off in the manner of conventional hub caps. **DO NOT ATTEMPT TO KNOCK OFF!**

USE OF TIRE CHAINS

Do not use tire chains on your Corvette rear wheels as clearance between tires and wheelhouse is insufficient to permit operation with chains installed.

INSTALLATION OF DOOR VENTILATOR AND WINDOW

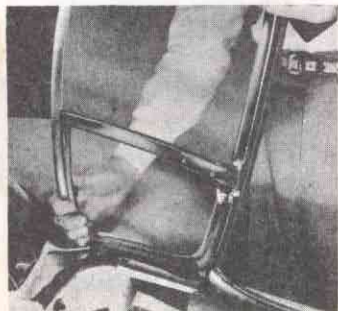

Fig. 34—Inserting Front Extension

1. Open door and insert offset extension on front bottom edge of window frame into slot in upper forward door area (fig. 34).

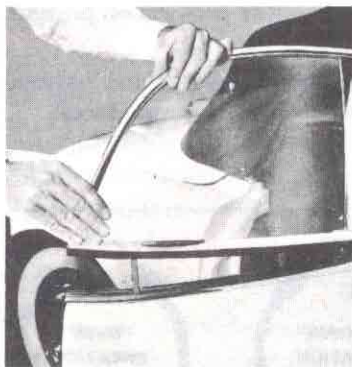

Fig. 35—Lowering Rear Extension

2. Lower serrated extension on bottom edge of assembly into slot in top of door to secure window at rear (fig. 35).

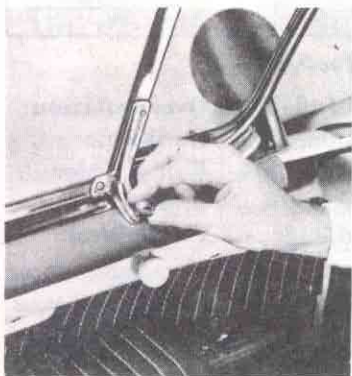

Fig. 36—Tightening Thumbscrew

3. Turn thumbscrew on brace at ventilator division strip into bracket in door trim rail to complete the installation (fig. 36).

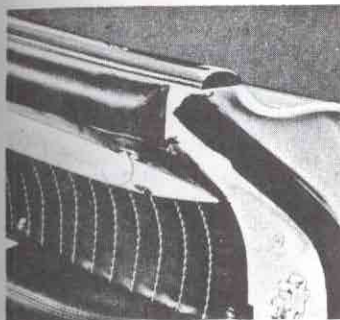

Fig. 37—Door Window Release Handle

4. To remove, loosen thumbscrew, pull back on ball handle at rear of door (fig. 37), lift up rear of assembly and remove by withdrawing offset extension from front of door

HOW TO RAISE THE FOLDING TOP

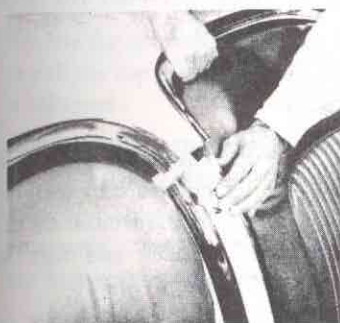

Fig. 38—Releasing Folding Top Lid

1. Push button on the panel between the seats to release the folding top lid, then, insert fingers under the lid and raise it to the open position (fig. 38).

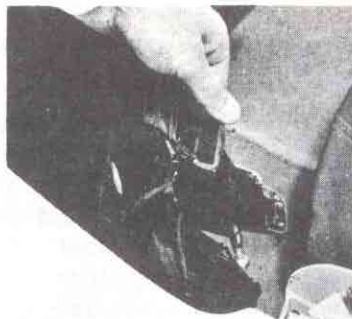

Fig. 39—Unbuckling Hold-down Straps

2. Unbuckle the straps holding each end of the top (fig. 39) and allow them to lay flat on the bottom of the top well.

NOTE: Straps extend over the header rail only, *not* around the entire top unit.



Fig. 40—Checking Material for Clearance

3. Check the cloth top material at each side to be sure it will be out of the way as the top iron comes up (fig. 40). Then, with the top material in the clear, lift the complete top by sliding a hand under the complete folded unit.



Fig. 41—Closing Folding Top Lid

4. Hold the still folded top all the way forward and close the folding top lid (fig. 41).

5. Lay the back section of the folded top down on the top of the lid.



Fig. 42—Locking Side Irons

6. Lift the header rail and unfold the side irons, then lock them in position and tighten thumbscrew (fig. 42).

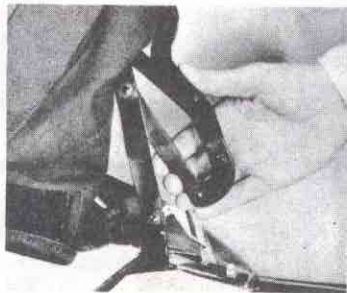

Fig. 43—Starting Link Cluster

7. Pull the header forward. It may be necessary to start the link cluster by pulling each side forward slightly (fig. 43) or the header can be pushed rearward after the side irons are locked. This will open the link clusters after which the header can be moved forward and rested on the windshield.



Fig. 44—Locking Top to Windshield Frame

8. Insert the over center clamps into the holes in the windshield side frames and lock up (fig. 44).

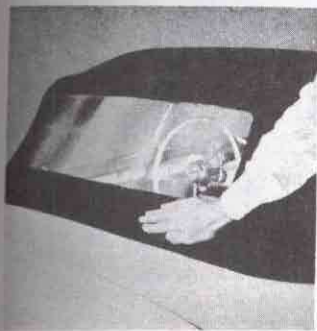

Fig. 45—Pushing Down
Rear Bow Catches

9. Turn around, depress the rear bow catches, insert the ratchet lever in the hole in the top lid and then push down tightly from the outside to permit the latch to catch (fig. 45).
10. Snap the fastener buttons on each side of the top just in back of the door opening.

HOW TO LOWER THE FOLDING TOP

- Reverse the procedure used to raise the top, being careful to pull the top material from between the links as the top is collapsed.
- Arrange the top material in the well to keep the side iron knobs off of the plastic backlight.
- Bring the hold down straps over the header rail only, *not* around the entire top unit. Arrange straps to protect top from chafing against the folding top lid.

NOTE: To prevent damage to paint finish, the folding top and luggage compartment lids are hinged so that both can not be fully opened at the same time.

CARE OF THE FOLDING TOP

To avoid water stains, mildew, or possible shrinkage of the top material, do not keep the top folded for extended periods of time if it is damp or water soaked. Permit top to dry out in a raised position before stowing. Also avoid pasting advertising stickers, gummed labels or masking tape on the plastic back window. In addition to being difficult to remove, the adhesive on these stickers may also be injurious to the plastic composition of the window. To clean the back window, use cold or warm water and a mild soap solution. After washing, rinse with clear water and wipe with a slightly moistened clean soft cloth. When removing road dust, do not use a dry cloth. Use a soft cotton cloth moistened with water and wipe cross-wise of the window to remove superficial dust. Never use solvents or cleaners of alcoholic or other chemical content. These liquids may possibly have a deteriorating effect on the plastic and also on the lacquer finish below the window if spilled.

HEADLIGHT SCREENS

A wire protector screen is provided to cover each headlight opening. Since some State Laws prohibit the use of such screens, it may be necessary to remove them in cases where a conflict with a State Law does exist. Where in doubt, it is recommended that the owner make a check to determine the legality of screens in the particular State in question. If removal is required, then proceed as follows:

1. Remove screw from bottom of chrome rim surrounding headlight opening (fig. 74).

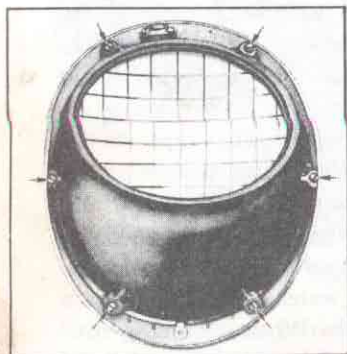

Fig. 46—Headlight Housing Retaining Screws

2. Lift up rim, screen, and housing assembly (fig. 75) and remove from opening.
3. Place assembly upside down, remove screws, indicated by arrows (fig. 46), retaining housing and screen to rim, and discard screen.
4. Reassemble housing to rim, install to headlight opening,

and secure at bottom with single screw.

LICENSE PLATE COMPARTMENT

The license plate is housed at the rear in a compartment within the luggage compartment lid (fig. 47). Access to this plate is gained by removing the screws securing the chrome bezel to the license plate opening and removing the chrome bezel and plastic cover from the opening.

NOTE: Some State Laws prohibit the use of these transparent license plate covers. Where in doubt, it is recommended that the owner make a check to determine legality of the license plate cover in the

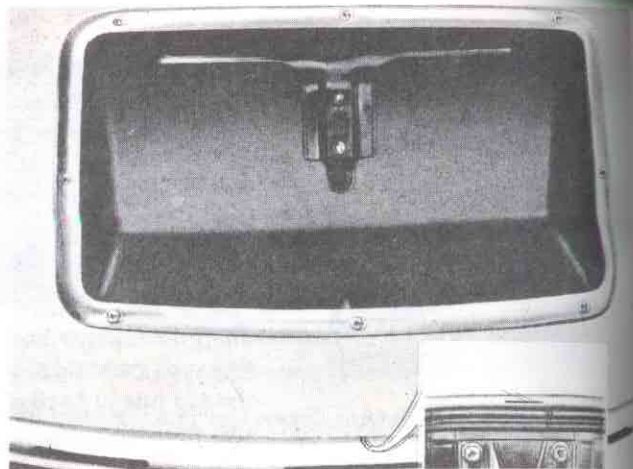

Fig. 47—License Plate Compartment

particular State in question. If removal of the cover is required, then proceed as follows:

1. Remove chrome bezel attaching screws and bezel.
2. Remove transparent plastic cover.
3. Replace bezel and attaching screws.
4. Clean out sealing compound in drain slot at lower edge of lid flange (inset, fig. 47). This will permit water trapped in the license plate compartment to drain out between inner and outer panels of the lid.

THE CORVETTE RADIO

The Corvette signal-seeking radio that is available as a factory installed optional accessory can be operated either manually, with push-buttons, or by means of a tuning bar. A description of the controls is contained below:

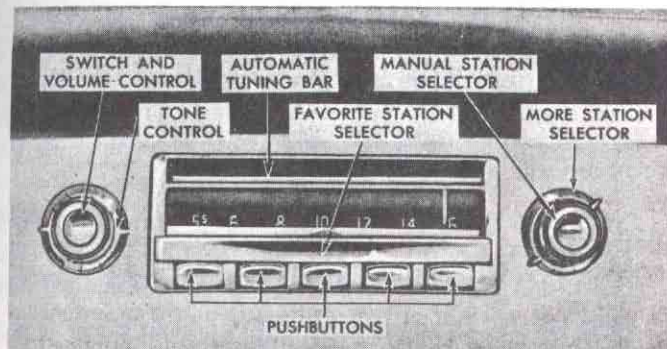

Fig. 48—Radio Controls

SWITCH AND VOLUME CONTROL—Rotate left knob clockwise to turn on radio and control volume.

TONE CONTROL—Rotate left ring to provide desired tonal quality.

MANUAL STATION SELECTOR—Rotate right knob to select desired station.

MORE STATIONS SELECTOR—Rotate right ring to

any one of four positions to determine range of stations available for selection with the automatic tuning bar. Turning this ring clockwise increases number of stations for tuning bar operation, while turning the knob counterclockwise decreases the number of stations available. In the extreme counter-clockwise position this control will select only the strongest available stations to give the most interference-free reception, while in the extreme clockwise position, the automatic tuning bar will automatically tune in any listenable station.

AUTOMATIC TUNING BAR—Push in automatic tuning or selector bar located above radio dial to reject station to which you are listening and advance toward right to nearest station in range that has been predetermined by the position of the more station selector ring. As this tuning bar is successively pushed in, the station position selected will advance toward the right until the end of the selected range is reached. Additional operation of the tuning bar will then automatically return to select again the first station in the predetermined range. If tuning bar is pressed in during push button operation, it will return the button in operation to the "off" position. Tuning bar operation will automatically accomplish fine tuning to select stations at positions of best reception on the band.

FAVORITE STATION SELECTOR—The favorite station selector is used to pre-select stations for push button

operation of the radio. It is located under a hinged plate above the push-buttons and consists of five red index pointed tabs that slide on a horizontal bar. The left tab corresponds to the left pushbutton, the second tab to the left to the second pushbutton to the left, etc. The stations may be pre-selected in accordance with the following procedure:

1. Warm up radio at least ten minutes. In sub-zero weather allow thirty minutes or more.
2. Move manual control knob to position of best reception of favorite station nearest left end of dial.
3. Open hinged plate to gain access to favorite station selector tabs and, as accurately as possible, move left red index tab until tip of tab lines up with the dial pointer.
4. Select the next favorite station to the right and push

the second tab so that it now lines up with the dial pointer.

5. This procedure should be followed until all five stations are selected in order to the right and all tabs are properly positioned. The buttons should now automatically tune in the desired stations and this can be checked by pushing each button to see if it selects the station which you have set up by the tab. If the station is not tuned in accurately, slide the tab slightly to the left or right until the button does automatically pick up the desired station.

PUSH-BUTTONS—Push in desired button to the full extent of its travel to select station that has been pre-set to the button with the favorite station selector described above.

ANTENNA—A screen type radio antenna is mounted between the luggage compartment lid inner and outer panels.

PERIODIC LUBRICATION AND MAINTENANCE

ENGINE LUBRICATION FIRST 500 MILES

The engine crankcase of your new Corvette is filled with a light body "breaking-in" oil at the factory and it is recommended that this oil be used for the first 500 miles. Check frequently and maintain the proper level. If it is necessary to add oil, use nothing heavier than SAE 10W oil. At the end of the first 500 miles, the crankcase should be drained—when hot—and refilled to the proper level with the recommended oil.

ENGINE LUBRICATION AFTER 500 MILES

After the first 500 miles, the oil should be changed every 2000-3000 miles. If equipped with an oil filter, the filter element should be changed at 6000-mile intervals. Adverse driving conditions such as dust storms, cold or severe weather, or very dusty roads may necessitate more frequent changes.

GRADES OF OIL

The grades of oil best suited for use in an engine at the various temperatures are shown in the following table:

If You Anticipate That the Lowest Atmospheric Temperature Will Be

Use Viscosity Grade

Not lower than 32° F. above zero	SAE 20W or SAE 20
Not lower than 10° F. above zero	SAE 20W
Not lower than 10° F. below zero	SAE 10W
Below 10° F. below zero	SAE 5W (see note)

NOTE: SAE 5W oils are particularly advantageous during low temperatures because of their easy starting and quick-flow characteristics. The easy starting characteristics of these oils greatly reduce the drain on the battery in cold weather.

At engine operating temperatures, the SAE 5W oils designated "For Service MS" are similar in viscosity, or body, to high quality SAE 10W oils and give equivalent lubrication protection and oil economy.

These oils are intended for use under all operating conditions and atmospheric temperatures that may be encountered when below zero temperatures are expected. They may be retained in the crankcase during the warmer days that occur during the winter season.

LUBRICATION POINTS

1. Lower Control Arm—Front (1 each side)
Chassis Lubricant..... 1,000 miles
2. Lower Control Arm—Rear (2 each side)
Chassis Lubricant..... 1,000 miles
3. Upper Control Arm—Front (1 each side)
Chassis Lubricant..... 1,000 miles
4. Upper Control Arm—Rear (2 each side)
Chassis Lubricant..... 1,000 miles
5. Front Wheel Bearings—High Melting Point
Front Wheel Bearing Lubricant..... 10,000 miles
6. Kingpin (2 each side)
Chassis Lubricant..... 1,000 miles
7. Tie Rod (2 each side)
Chassis Lubricant..... 1,000 miles
8. Steering Gear—Add Gear Lubricant
When Necessary..... 1,000 miles
9. Transmission (See Pages 26 and 28)
10. Rear Axle (See Pages 26 and 28)
11. Generator (2 Oil Cups)
Light Engine Oil (See Page 26)..... 1,000 miles
12. Distributor (1 Cup)
Chassis Lubricant (See Page 27)..... 1,000 miles
13. Throttle Bell Crank
Light Engine Oil..... 1,000 miles
14. Solenoid Linkage (See Page 26)..... 1,000 miles
15. Steering Connecting Rod (1 each end)
Chassis Lubricant..... 1,000 miles
16. Transmission Shift Lever Shaft (1 fitting)
Chassis Lubricant..... 1,000 miles
17. Air Inlet Extension (1 each carburetor)
Not Illustrated—(See Page 27)..... 2,000 miles

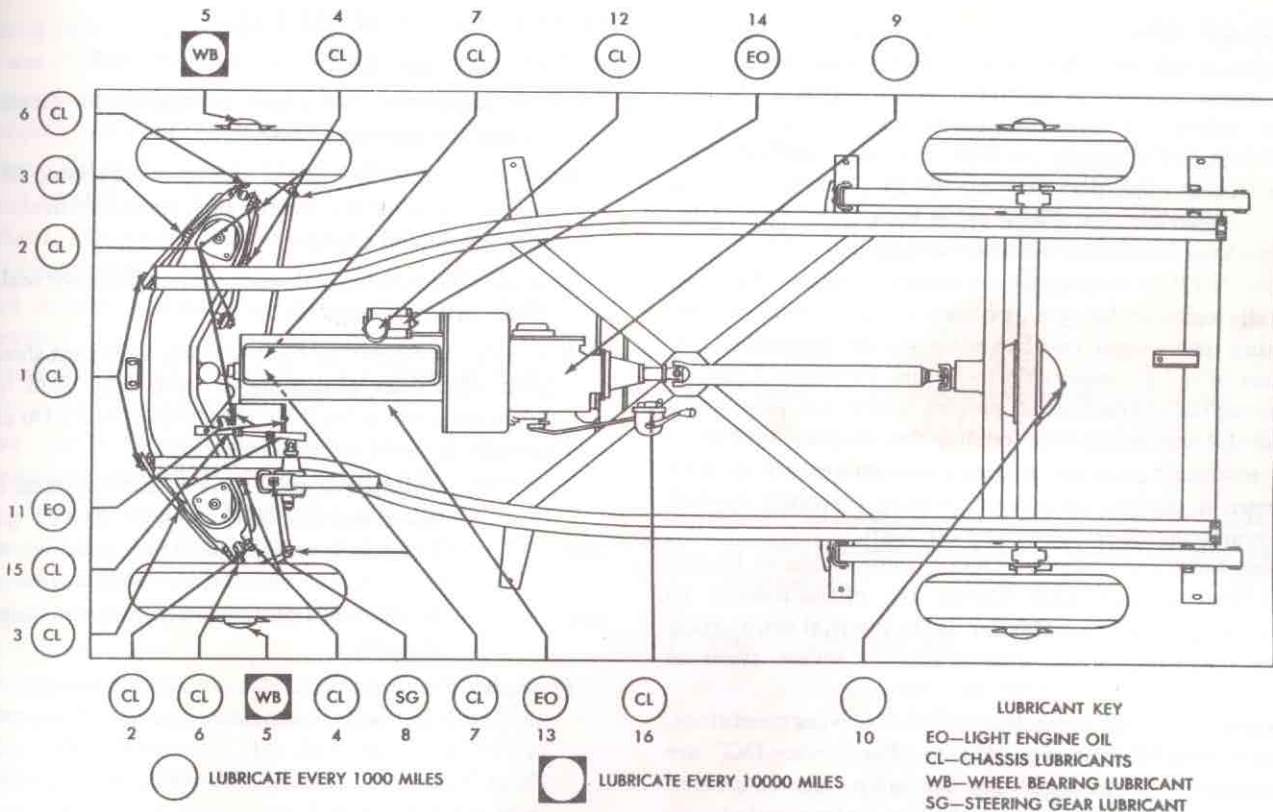

Fig. 49—Lubrication Chart

TYPES OF OIL

In service, crankcase oils may form sludge and varnish and under some conditions corrosive acids unless protected against oxidation. To minimize the formation of these harmful products and to supply the type of oil best suited for various operating conditions, the oil industry markets several types of crankcase oils. These types have been defined by the American Petroleum Institute as follows:

“Service ML” (Comparable to former Regular Type)—Generally suitable for use in internal combustion engines operating under light and favorable service conditions.

“Service MM” (Comparable to former Premium Type)—Oil having the characteristics necessary to make it generally suitable for use in internal combustion engines operating under moderate to severe service conditions which present problems of sludge, varnish or bearing corrosion control when crankcase oil temperatures are high.

“Service MS” and “Service DG” (Comparable to former Heavy-Duty Types)—Oils having the characteristics to make them generally suitable for use in internal combustion engines operating under unfavorable or severe types of service conditions.

For maximum engine protection under all driving conditions, oils designated “For Service MS” or “For Service DG” are recommended. If these are not available, oils designated “For Service MM” may be used. Not recommended: oils designated “For Service ML.”

MAINTENANCE SCHEDULE

EVERY 1000 MILES

Chassis Lubrication: See pages 24 and 25 for location of chassis lubrication points.

Starter Solenoid: A few drops of engine oil should be used on the pivots of the starter shift lever mechanism. Do not oil solenoid plunger.

Generator: Fill cups at both ends of the generator with SAE 20 oil. Also see page 60.

Rear Axle: At operating temperature, lubricant should be level with filler plug hole in each unit. Add hypoid lubricant such as SAE 90 “Multi-Purpose”. Do not use straight mineral oil gear lubricants.

NOTE: “Multi-Purpose” gear lubricants must be the latest non-corrosive type of proved quality. The lubricant manufacturer must be responsible for the satisfactory performance of his product. His reputation is your best indication of quality.

Powerglide Transmission: Check oil level with engine idling, parking brake set, transmission warm and control lever in “N” position. Add only “Automatic Transmission Fluid Type A”, bearing an AQ-ATF number when level reaches “Add 1 qt.” mark on oil level rod. Do not allow dirt to enter filler tube.

Steering Gear: Check level and fill with steering gear lubricant. "Multi-Purpose" gear lubricant may be used.

Distributor: Lubricant cup on side of housing is filled with chassis lubricant. Turn cup down one full turn.

Battery: Fill to $\frac{1}{4}$ " above plates with distilled water. Do not overfill.

Radiator: Maintain coolant level 1" below top of the auxiliary tank.

Shock Absorbers: Sealed type shock absorbers require no service.

Throttle Rod Bell Crank: Apply a few drops of engine oil. Do not oil carburetor linkage.

Brake Master Cylinder: Maintain level $\frac{1}{2}$ " below filler opening. Use GM Hydraulic Brake Fluid, Super No. 11.

Hood Latch Mechanism: Apply light engine oil.

Door Lock Bolts and Striker Plates: Use light oil on lock bolt gears and striker plates.

Luggage Compartment Lid Lock Cylinder: Lubricate with powdered graphite.

Luggage Compartment Lid Lock Mechanism: Lubricate moving parts with cup grease.

EVERY 2,000—3,000 MILES

Engine Crankcase: Drain and refill, using lubricants as recommended on pages 23 and 26. If flushing is desired,

use only SAE 10W oil (3 qts.), and run engine at fast idle until oil is hot. Drain immediately and fill with correct grade of oil.

Carburetor Air Inlet Extensions: Inspect screens and remove any accumulation of foreign material. If extensions are removed they must be aligned when installed with the "V" on the extension in line with the center of the boss on the carburetor air horn.

EVERY 5,000 MILES

Distributor: Apply a little petroleum jelly to cam.

Spark Plugs: Remove, clean and regap plugs to .035".

Tires: Rotate tires as described on page 15.

Rear Springs: Spring leaves are permanently lubricated by non-metallic liners and do not require periodic lubrication.

EVERY 10,000 MILES

Front Wheel Bearings: Remove wheel, hub and drum assembly. Clean and repack bearings with high melting point grease. Do not pack hub between inner and outer bearings or the hub cap. Adjust bearings as described on pages 31 and 32, steps 2-5, and replace wheel, hub and drum assembly.

MAINTENANCE IN BRIEF

The table below indicates some of the things which should be done at regular intervals.

Mileage	Lubricate Chassis	Change Oil	Clean Spark Plugs	Rotate Tires	Check Brake Adjustment	Tune Engine	Complete Inspection by Dealer	Pack Front Wheel Bearings
500		*						
1000	*						*	
2000	*	*						
3000	*							
4000	*	*						
5000	*		*	*	*	*	*	
6000	*	*						
7000	*							
8000	*	*						
9000	*							
10000	*	*	*	*	*	*	*	*

After 10,000 miles repeat above schedule starting with 1,000 mile operations at 11,000, 21,000, 31,000 miles, etc. Change Powerglide Transmission oil every 25,000 miles.

The following operations should be done as indicated.

Period	Check Battery	Check Air in Tires	Add Anti-Freeze	Flush Cooling System
2 Weeks	*	*		
Spring				*
Fall			*	*

Rear Axle: Normally, seasonal changes are not required but may be advisable in severe service. Refill with hypoid lubricant such as SAE 90 "Multi-Purpose" gear lubricant. Do not use straight mineral oil gear lubricant.

EVERY 25,000 MILES

Powerglide Transmission: Drain and refill. Flushing is not recommended. Before draining, warm up transmission. Remove drain plug from sump. After draining, replace plug. Fill using four (4) quarts of "Automatic Transmission Fluid Type A" bearing an AQ-ATF number. Idle engine in neutral with hand brake set. After a few moments, check oil level and if necessary, add enough oil to bring it up to the full mark on the dip stick.

DESIGN AND MINOR MAINTENANCE INFORMATION

BODY AND FRAME

The Corvette body is composed of plastic glass fiber material molded into one compact unit and covered with a Duco finish. The glass fiber material is light weight, has excellent strength properties, and will not corrode or be affected by oil, grease, weathering, or most chemicals. It will not dent but may be punctured, cracked, torn, or otherwise damaged by very large forces such as produced by sudden impact or shock contact. See your Chevrolet Dealer in the event of damage to the body of your Corvette.

The frame is the structural center of the vehicle for in addition to carrying load, it furnishes support for the body, engine, transmission system and other units. The frame maintains correct relationship of all parts in order to secure their normal function and freedom from stress and strain and wear that may be caused by operation in a misaligned condition.

The Corvette frame (fig. 50) consists basically of a front cross member (not shown), full-length side rails, "I" beam type "X" member, bracing from "X" member to front frame side member, rear shock absorber cross member, rear cross member, and various mounting brackets.

The front cross member is a large semi-tubular unit which is saddle mounted and bolted rigidly to the frame side



Fig. 50—Frame

members. The use of bolts in place of rivets facilitates overhaul as the complete front end assembly may be removed from the frame as a unit.

Vehicles which have been in a collision, upset, or in an accident of any nature which might result in "swayed" or "sprung" frame should always be checked for proper frame alignment in addition to steering geometry and wheel alignment. When necessary, it is recommended that your Chevrolet dealer be contacted for checking the frame alignment of your Corvette.

FRONT SUSPENSION

The front wheels on the Corvette are independently sprung by the S.L.A. (short and long arms) method. This design allows the wheel to move up or down independently in following irregularities of the road, resulting in a minimum of tire wear due to scrubbing of tires against road surface.

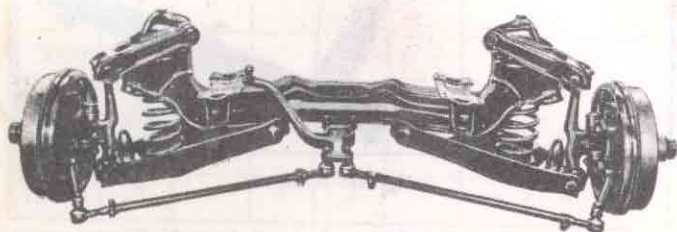

Fig. 51—Front Suspension

Whether these irregularities be raised obstructions or chuck holes, the shock will not be transmitted to the car or occupants.

In this construction the entire assembly (fig. 51) is attached to an usually rugged frame cross member which is semi-tubular in design and is saddle mounted and bolted rigidly to the frame side members. This construction facilitates complete overhaul or replacement in that the complete assembly may be removed from the frame as a unit.

FRONT SHOCK ABSORBERS

Direct acting, permanently sealed bayonet type front shock absorbers are located in the center of each front spring (fig. 52) and operate in a vertical plane. The top of the shock absorber is attached to the top of the spring housing and the bottom is stem attached to a removable plate attached to the lower control arm. Since front shock absorbers are permanently sealed,

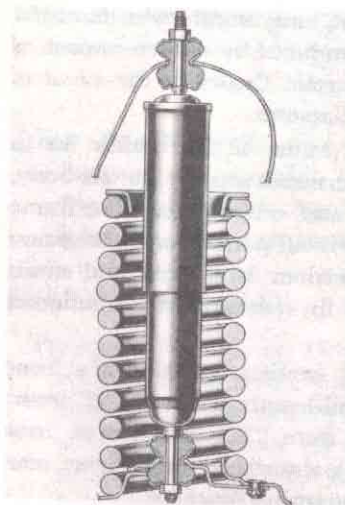

Fig. 52—Front Shock Absorber Mounting

service operations are limited to replacements only. Front shock absorbers may be replaced on the vehicle as follows:

Removal

1. With a $\frac{1}{4}$ " open end wrench, hold upper stem from turning and remove upper stem retaining nut, grommet retainer and grommet.
2. Remove nut and lockwasher from special bolt retaining shock absorber lower mounting bracket to lower control arm and pull shock absorber assembly and mounting bracket out bottom of spring housing (fig. 53).



Fig. 53—Removing Front Shock Absorber

3. Place mounting bracket in vise and remove lower stem retaining nut, grommet retainer and grommet and remove shock absorber from mounting bracket.
4. Inspect rubber grommets for condition and, if necessary, replace with new grommets.

Installation

1. Install grommet retainer, upper grommet, retainer bracket assembly, lower grommet and grommet retainer

on bottom stem of shock absorber and install grommet retainer nut and tighten until it bottoms on shoulder of stem. Then tighten to 4-6 ft. lbs. torque and stake in place.

2. Install grommet retainer and grommet on upper stem of shock absorber and install shock absorber up through lower control arm and spring housing.
3. Index upper stud through mounting hole in top of spring housing and index mounting hole in shock absorber retainer bracket over special bolt in lower control arm.
4. Install lockwasher and nut on special bolt and tighten nut securely.
5. Install grommet and grommet retainer over upper stem of shock absorber.
6. Install retainer nut to upper shock absorber stem and holding stem with $\frac{1}{4}$ " wrench, tighten nut until it bottoms on shoulder of stem. Then tighten to 4-6 ft. lbs. torque and stake in place.

FRONT WHEEL BEARINGS—ADJUST

The proper adjustment of front wheel bearings is one of the important service operations that has a definite bearing on safety. A car with improperly adjusted front wheel bearings lacks steering stability, has a tendency to wander or shimmy and causes excessive tire wear. In an effort to provide for more accurate

adjustments the spindles are drilled both vertically and horizontally and adjusting nuts are slotted on all sides.

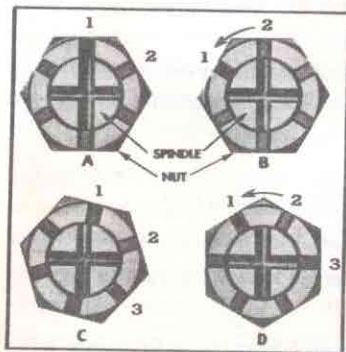

Fig. 54—Method of Adjusting Front Wheel Bearings

- back off the nut ($\frac{1}{6}$ turn) until the next slot in the nut lines up with the same hole in the spindle and insert cotter pin (see B, fig. 54).
- If, when the spindle nut is tightened to 33 foot pounds, the slot in the nut has passed beyond vertical or horizontal holes in spindle (see C, fig. 54), back off the nut a sufficient amount (less than $\frac{1}{6}$ turn) to line up the second next slot in nut and the other hole in the spindle.
- To illustrate this point the slots in the nut are indicated 1, 2 and 3 (see D, fig. 54). If the slot marked 1 on the

- Raise vehicle off floor and remove wheel and hub grease cap
- Tighten spindle nut to 33 foot pounds with a torque wrench.
- Check the location of a slot in the nut with reference to a hole in the spindle. If a slot in the nut lines up with either the vertical or horizontal holes in the spindle (see A, fig. 54),

nut is slightly beyond the vertical hole in the spindle, the nut should be backed off until the slot marked 3 is in line with the horizontal hole in the spindle. It will be noted that the nut has been backed off slightly less than $\frac{1}{6}$ turn.

NOTE: Front wheel bearings should never be set up on the loose side as such an adjustment does not bring the balls and races into proper contact.

- Install hub grease cap and wheel. Lower vehicle to floor, retighten wheel hub bolt nuts and install hub caps.

REAR SUSPENSION

The rear suspension incorporates a hypoid, semi-floating rear axle with six ball and roller bearings and a 3.55:1 ratio. A Hotchkiss type drive is employed in which the driving force and torque is taken by the rear springs.

The rubber-cushioned semi-elliptic rear springs are mounted outboard of the frame. The spring eyes are mounted on each side at the front to a bracket riveted to the rear outrigger bracket and at the rear in a shackle bolted to a bracket welded to the frame rear cross member outside the frame side rail. The shackles are of the center pressure type with spool-shaped rubber inserts having spherical ends at the spring rear eyes.

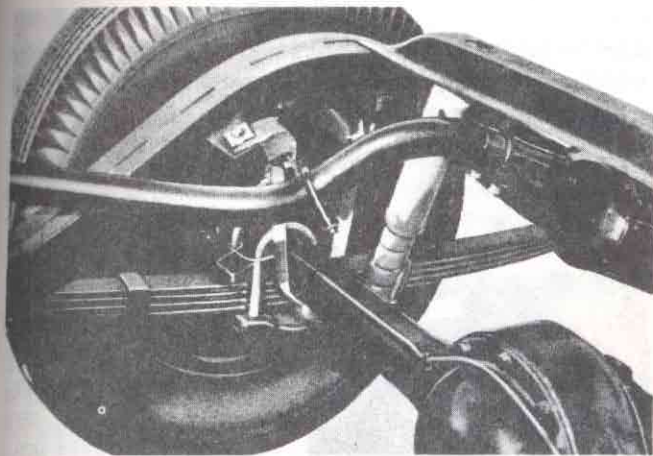

Fig. 55—Rear Suspension

Rebound straps of belting type material (fig. 55) are fastened to brackets welded to the bottom of the frame and looped around the axle to provide a limited rebound. These straps are necessary with the standard type shock absorbers used to provide a controlled ride as the spring might otherwise travel farther than the extended length of the shock absorbers.

REAR SHOCK ABSORBERS

Rear shock absorbers on the Corvette are the non-adjustable direct-acting bayonet type, which are stem attached at the

top to slotted holes in a flanged U-shaped channel cross member at the kick-up and eye attached at the bottom to an anchor bolt in the rear spring "U" bolt and shock absorber anchor bolt plate (fig. 55). These shock absorbers are permanently sealed and require no maintenance other than replacement, which may be performed as follows:

Removal

1. Raise folding top compartment lid and remove folding top from top compartment area.

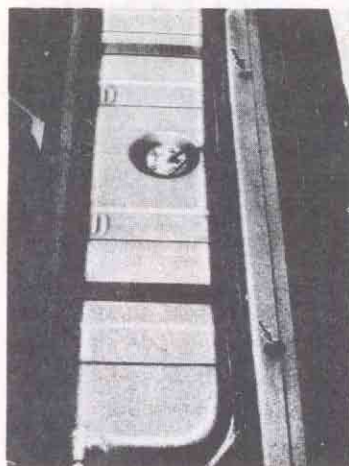

Fig. 56—Folding Top Compartment With Bottom Removed

2. Remove top compartment bottom board retaining screws and remove bottom board (fig. 56.)
3. Holding upper stem from turning, remove upper shock absorber retaining nut through hole in frame cross member indicated by arrow (fig. 56), then remove upper grommet retainer, grommet, and lower grommet retainer from shock absorber upper stem.

4. Remove nut, lockwasher and flat washer from shock absorber anchor bolt on rear spring "U" bolt and shock absorber anchor bolt plate.
5. Pull or drive lower shock absorber eye from anchor bolt and drop down to disengage upper stem from shock absorber frame cross member.
6. Inspect rubber grommets for condition and if necessary replace with new grommets.

Installation

1. Install rubber bushings in shock absorber eye and install grommet retainer, grommet and grommet retainer to shock absorber upper stem.
2. Install steel flat washer on shock absorber anchor bolt and then install shock absorber, indexing upper stem through hole in shock absorber frame cross member and installing lower shock absorber eye to anchor bolt.
3. Install steel flat washer, lockwasher and nut to anchor bolt and tighten securely.
4. Install grommet retainer, grommet and grommet retainer to upper stem through folding top compartment.
5. Install retainer nut to upper stem and holding stem from turning, tighten nut until it bottoms on shoulder of stem. Then tighten to 4-6 ft. lbs. of torque and stake in place.
6. Install and seal the folding top compartment bottom board.

BRAKES

The brakes used on the Corvette are a self-energizing type which combine hydraulically operated service brakes with mechanically operated parking brakes.

The Corvette foot brake employs a pendent-type pedal that is supported from the main cylinder which is mounted on the dash panel (fig. 57).

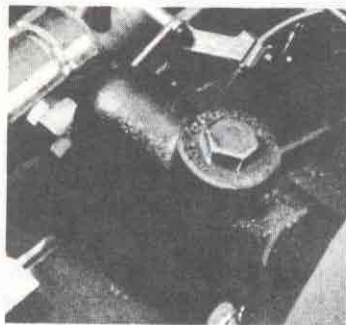

Fig. 57—Brake Main Cylinder

Operation of the hydraulic system is dependent upon the proper functioning of main and wheel cylinders. The main cylinder piston receives mechanical pressure from the brake pedal and push rod and exerts pressure on the fluid in the lines, building up the hydraulic pressure which is transmitted to the wheel cylinders. This fluid pressure forces the pistons in the wheel cylinders outward, expanding the brake shoes against the drums. As the pedal is depressed further, higher pressure is built up within the hydraulic system causing the brake shoes to exert greater pressure against the brake drums.

As the pedal is released, the hydraulic pressure is relieved

and the brake shoe retracting springs draw the shoes away from the drums and force the fluid out of the wheel cylinders back into the lines toward the main cylinder.

The mechanical parking brake uses a simplified form of linkage. The parking brake handle, located under the left side of the instrument panel is connected by a flexible cable to the equalizer lever just to the rear of the frame "X" member. The cables are supported at the rear wheels by special clamps to permit the cables to pass under the springs.

HYDRAULIC BRAKE FLUID

Only G. M. Hydraulic Brake Fluid Super No. 11 should be used when bleeding brakes. This brake fluid is satisfactory for any atmospheric temperature, hot or cold and has all the qualities necessary for satisfactory operation, such as a high boiling point to prevent evaporation and tendency to vapor lock, and a fluid state at low temperatures.

BLEEDING HYDRAULIC SYSTEM

Air in the hydraulic system must be removed by a bleeding operation after the system has been opened at any point, or when air has entered the system in any manner. Air in the system is usually indicated by:

1. A "spongy" or "springy" feeling of the brake pedal when the brakes are applied.
2. Too much travel of the brake pedal (when the brake shoe adjustment is known to be correct).

Bleeding should be done on the longest line first to remove effectively all air from the system. The proper sequence to follow is left rear, right rear, right front and left front. In the bleeding operation it is extremely important that absolute cleanliness be observed. Any foreign matter in the system will tend to clog the lines, ruin the rubber cups of the main and wheel cylinders and cause inefficient

operation or even failure of the braking system.

The manual method of bleeding the brake lines is described below. It is recommended that a helper be used to assist in performing this operation.

1. Raise hood, clean all dirt from top of main cylinder mounted on the dash panel, and remove filler plug.
2. Fill the reservoir with brake fluid. The reservoir must be kept full, or nearly full, of brake fluid while bleeding the brake system.



Fig. 58—Bleeding Brakes at Wheel Cylinder

3. Remove bleeder valve screw from end of bleeder valve near the brake fluid pipe or hose connection at wheel.
4. Attach a bleeder hose to the bleeder valve at this point (fig. 58) and place the free end of the bleeder hose in a clean container having sufficient fluid to cover end of hose. Keep the end of this hose covered with fluid at all times during this operation.
5. With a wrench, open bleeder valve by turning $\frac{3}{4}$ turn in a counter-clockwise direction.
6. Slowly depress the brake pedal by hand to approximately the halfway point, then let the pedal return slowly to the release position. Repeat this procedure several times, keeping the end of the hose submerged in brake fluid until the fluid expelled from the bleeder hose is free of air bubbles.
7. Close bleeder valve tightly by turning clockwise with wrench as soon as bubbles stop and fluid flows in a solid stream.
8. Remove bleeder hose and install bleeder valve screw in bleeder valve.
9. Add new fluid to the main cylinder, and repeat the operation on the other wheels in turn.

HYDRAULIC BRAKE ADJUSTMENT

To compensate for lining wear, which is evidenced by excessive pedal travel, a minor adjustment can be made to

reduce the clearance between the brake lining and brake drum. All hydraulic brakes can be adjusted without removal of the wheels as all brake flange plates have openings with removable spring snap covers. As brakes are self-energizing through energizing links, only one service adjustment at each wheel cylinder is needed.

1. Jack up wheel and remove adjusting hole cover from flange plate.
2. Through hole in flange plate, insert screw driver or similar tool and engage it in teeth of adjusting wheel (fig. 59).

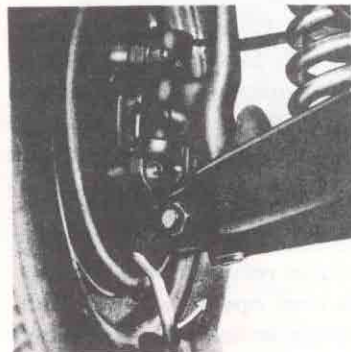

Fig. 59—Adjusting Brakes

3. To expand shoes, move outer end of tool toward center of wheel until shoes drag slightly.
4. Turn adjusting wheel in opposite direction 7 notches to insure running clearance and check to see that wheel turns freely without drag. It may be necessary to tap backing plate to permit shoes to centralize before brake will be free.
5. Repeat this operation on each brake and replace hole covers.

A major adjustment, which is not covered in this manual, becomes necessary when a minor adjustment will not provide a satisfactory brake. See your Chevrolet dealer if a major adjustment becomes necessary.

PARKING BRAKE ADJUSTMENT

The parking brake adjustment should be checked each time the hydraulic brakes are adjusted. When making a parking brake adjustment, the service brakes must be properly adjusted first as a base for the parking brake adjustment.

1. Jack up both rear wheels.
2. Pull out hand brake handle for 7 clicks of pawls (not 7 notches).
3. Loosen check nuts at cable ends. Turn the forward check nuts against the clevis plates to draw up each brake cable until a moderate drag is felt when rotating drum.
4. Tighten check nuts securely.
5. Set parking brake lever back to 2 clicks from full release position, at which point no brake shoe drag should be felt.

ENGINE

The Corvette engine consists of the basic 235.5 cubic inch Chevrolet engine with a multitude of mechanical improve-

ments which provide a more rapid response to power demands upon acceleration and at higher top speeds. Along with the changes made to the engine, triple carburetion to give an increased fuel-air charge to the intake manifold and a dual exhaust system that permits a rapid expelling of exhaust gases have been provided.

The combustion chamber of the new cylinder head has a reduced overall volume to provide an increased compression ratio.

The intake valves are made of silchrome steel and the exhaust valves of XCR steel to withstand high temperatures.

The high lift type camshaft has lobes machined to a greater height to permit both intake and exhaust valves to open farther into the head. This permits a greater charge of fuel-air mixture to enter the intake manifold and the cylinder during the high intake valve opening and at the same time provides for more rapid expulsion of exhaust gases to the exhaust manifold while the exhaust valve is at the high opening. The valve rocker cover is of new design being retained in position by four slotted head bolts and having tabs on the right side for attaching the ignition shield.

The intake manifold is made of cast aluminum and designed to accommodate the three side mounted carburetors (fig. 60). It contains an internal surge tube which connects the

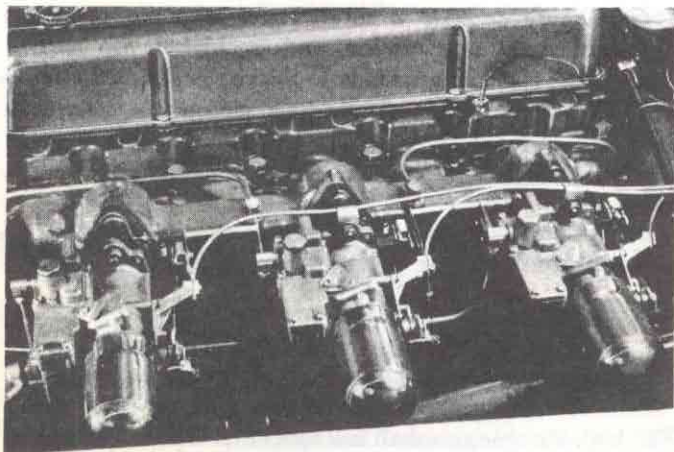

Fig. 60—Corvette Triple Carburetion

three passage ports. The surge tube maintains a balanced fuel-air charge to each cylinder as required during engine operation, resulting in smooth and efficient engine operation and increased horsepower.

The basic exhaust manifold design consists of two outlets instead of one, divided by an internal wall at the rear of the heat box. When using the manifold heat control valve, the exhaust gases from the front three cylinders are directed to the heat valve in the heat box. Part of these gases are then directed by the valve to the intake manifold to preheat the

incoming charge during warm-up. This portion of the gases then rejoins the original stream to be expelled through the front exhaust pipe, right hand muffler and tail pipe. The exhaust gases from the rear three cylinders are carried away by the rear outlet and expelled through the left hand tail pipe. However, it has been determined that manifold heat control valve operation is neither necessary nor desirable under normal temperature and operating conditions encountered with your Corvette. Consequently a manifold heat shield has been installed between the exhaust and intake manifolds to direct exhaust gases from the front three cylinders away from the intake manifold, thus eliminating preheating of the incoming charge. Also, the heat control valve spring has been reversed so as to hold the valve continuously in a "heat-off" position. If preheating of the incoming charge is desired for extreme cold weather operation, it will be necessary to remove the heat shield and reverse the heat control valve spring. It is recommended that your Chevrolet dealer be consulted for advice concerning this modification. Where it is advocated, this modification should be performed by your dealer who is better equipped to do this work.

The pistons used are the light-weight, expansion-controlled, aluminum type with the piston pin offset by $\frac{5}{64}$ inch. This feature reduces the possibility of piston noise, providing a quieter engine operation under all loading conditions.

A four way lubrication system is provided with (1) full pressure to main bearings, connecting rod bearings, camshaft bearings, (2) metered pressure to valve mechanism and timing gear, (3) pressure jet to cylinder walls, (4) splash to piston pins.

The cooling system provides adequate cooling to the Corvette high output engine. Notable cooling system features are an 18 inch fan, new larger water pump, and full length water jackets in the engine.

A fuel filter is provided as standard equipment in the Corvette. This filter should be checked if fuel system trouble is encountered and the filter element replaced if necessary. The Corvette owner may be able to improve the performance and economy of his vehicle substantially by performing a few important minor engine service adjustments when required. The operations described below are considered to be within the scope of owner maintenance since they may be performed without resort to costly special tools or equipment. It is recommended that your Chevrolet dealer be consulted regarding engine conditions requiring adjustments or servicing other than described herein.

COMPRESSION CHECK

Before making any checks on an engine it should be run for several minutes and allowed to warm up. Lubricate the valve mechanism. The compression of each cylinder should

be checked first because AN ENGINE WITH UNEVEN COMPRESSION CANNOT BE TUNED SUCCESSFULLY.

1. Turn the ignition off and block the throttle in an open position.

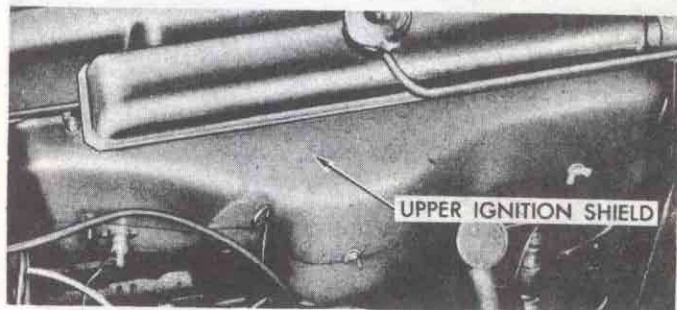

Fig. 61—Upper Ignition Shield

2. Remove upper ignition shield (fig. 61) to expose spark plugs (fig. 62).
3. Remove all spark plugs from engine.
4. Insert compression gauge in a spark plug hole and hold it tightly in position. Crank the engine with the starting motor until gauge reaches its highest reading, which requires only a few turns of the engine.
5. Repeat this test on all cylinders and make a note of the compression reading on each cylinder.

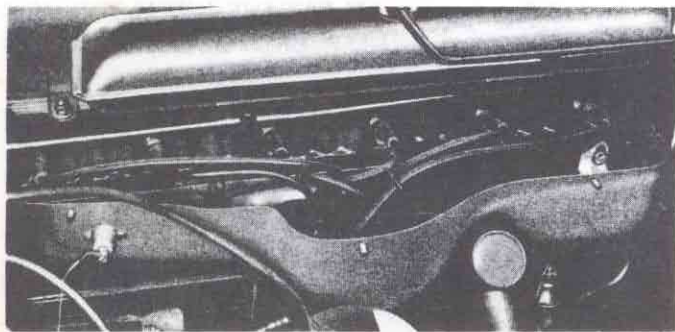

Fig. 62—Upper Ignition Shield Removed

6. Compression on all cylinders should be 130 pounds or better. All cylinders should read alike within 5 to 10 pounds for satisfactory engine performance.

Should a low compression reading be obtained on two adjacent cylinders, it indicates the possibility of a leak from one cylinder to the other, usually caused by a leak at the cylinder head gasket.

If the compression readings are low, or vary widely, the cause of the trouble may be determined by injecting a liberal supply of engine oil on top of the pistons of the low reading cylinders.

Crank the engine over several times, and then take a second compression test. If there is practically no difference in the readings when compared with the first test, it indi-

cates sticky or poorly seating valves. However, if the compression on the low reading cylinders is higher and about uniform with the other cylinders it indicates compression loss past the pistons and rings.

The cause of low or uneven compression must be corrected before proceeding with an engine tune-up job.

SPARK PLUGS

To gain access to the spark plugs, the upper ignition shield (fig. 61) must be removed. It is important that this shield be replaced when servicing is complete.

Clean the spark plugs thoroughly using an abrasive type cleaner. If the porcelains are badly glazed or blistered, the spark plugs should be replaced. All spark plugs must be of the same make and number or heat range.

Adjust the spark plug gaps to .035" using a round feeler gauge (fig. 63).

CAUTION: In adjusting the spark plug gap, never bend the center electrode which extends through the porcelain center.

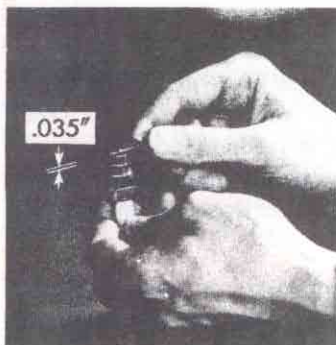

Fig. 63—Setting Spark Plug Gap

Always make adjustment by bending the side electrode. Install the spark plugs in the engine blowing away dirt from around plug holes and using new gaskets whenever necessary and tightening to 20-25 foot pounds tension. If torque wrench is not available, tighten finger tight and $\frac{1}{2}$ turn more using new gaskets. Plugs are of 14-millimeter size and care must be exercised when installing or the setting of the gap may be upset.

VALVE ADJUSTMENT

Before adjusting the valve stem to rocker arm clearance, it is extremely important that the engine be thoroughly warmed up to normalize the expansion of all parts. This is very important because the valve clearances will change considerably during the warm-up period. Adjusting the valves during or before this warm-up period will produce clearances which will be far from correct after the engine reaches normal operating temperature.

Tests have shown that valve clearances will vary as much as .005" from a cold check through the normalizing range. To normalize all parts properly, the engine should be run approximately 30 minutes.

Covering the radiator will not materially hasten this normalizing process because even with the water temperature quickly raised to 185°, the rate at which the oil temperature increases or the engine parts become normalized does not change appreciably.

The actual temperature of the oil is not as important as stabilizing the oil temperature. The expansion or contraction of the valves, rocker arm supports, push rods, cylinder head and cylinder block are relative to this oil temperature. Therefore, only after the oil temperature is stabilized do these parts stop expanding and valve clearances cease to change.

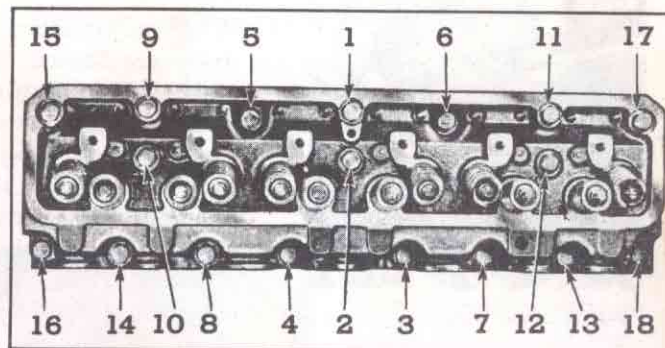

Fig. 64—Cylinder Head Bolt Tightening Diagram

1. Remove the upper ignition shield.
2. Remove rocker arm cover attaching bolts and cover.
3. Tighten all manifold bolts (4 center clamp bolts 15-20 ft. lbs. torque; 2 end clamp bolts 25-30 ft. lbs. torque), valve rocker shaft support nuts and bolts (25-30 ft. lbs. torque) and cylinder head bolts (90-95 ft. lbs. torque) in sequence shown in Figure 64.

- Lubricate valve stems with engine oil to insure free movement of valves in their guides.
- With engine normalized, check the clearance between the rocker arms and the valve stems with a feeler gauge (fig. 65). The clearance should be:

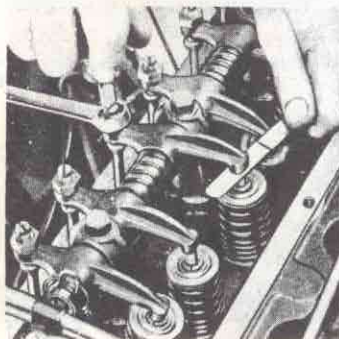

Fig. 65—Valve Tappet Adjustment

Intake .010"
Exhaust .020"

- When adjustment is necessary loosen the rocker arm adjusting screw lock nut and turn the screw clockwise slightly to decrease the clearance and counter-clockwise to increase clearance. Tighten lock nut and recheck clearance.

- Install rocker arm cover using a new gasket. Make sure cover seats properly on gasket and tighten retaining bolts. Check for oil leaks and install upper ignition shield.

DISTRIBUTOR POINTS

Correct distributor point gap is very important. If the condition of the distributor points is questioned, proceed as follows:

Inspection and Cleaning

- Remove the upper ignition shield.
- Remove spark plug wires from distributor cap and examine terminals for corrosion. The wires should be checked for damaged insulation and oil soaked condition.
- Release the distributor cap clamps, remove cap and lift off rotor. Check cap and distributor rotor for cracks, burned, or pitted contacts.
- Separate the points and inspect them for pitted or badly burned condition.
- Clean the points with a breaker point file removing the high spots only. Do not use emery cloth or sandpaper to clean points. If the points do not clean up with a few strokes of the file, they should be replaced as described in following steps 6-10.

Replacement

- Loosen the inside terminal nut at the movable point spring and lift the point out.
- Remove the stationary point lock screw and remove point and arm.
- Carefully wipe the protective film of oil from the contact points of the new set.

9. Place the new stationary point and arm in position and install the lock screw.
10. Place the movable point on its shaft and position the spring on the terminal behind lock clip and tighten nut securely. Adjust points as described in following steps 11-15.



Fig. 66—Adjusting Distributor Points

Adjustment

11. Crank the engine until the distributor point cam follower rests on the peak of the cam.
12. Check the point opening using a feeler gauge (fig. 66). Correct adjustment is .016" for used points and .019" for new points. If necessary to adjust the points, loosen the stationary point lock screw and turn the eccentric screw as necessary. This operation must be performed very accurately because it affects the point dwell or length of time the points remain closed in operation and, in turn, ignition coil performance.
13. Tighten lock screw and recheck point opening.

14. Check breaker arm tension. Crank engine until cam follower is located between cams. Using a distributor point scale, hook end of scale over movable point and pull steadily on the spring scale until the points just start to open. At this point the reading on the scale should be between 19 and 23 ounces. Adjust if necessary by loosening outside terminal nut on distributor and moving spring to give desired tension.
15. Install rotor, place cap on distributor and turn it until it drops into locking position. Clamp the cap in position and install spark plug wires to cap. Make sure that the terminal of the primary wire at the ignition coil and distributor are clean and tight. Replace upper ignition shield.

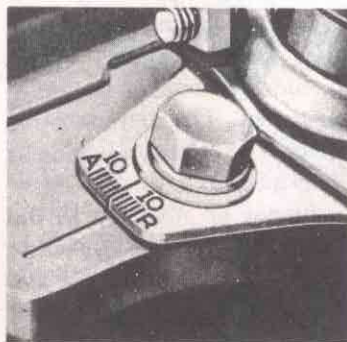

Fig. 67—Octane Selector

OCTANE SELECTOR

Since differences exist in various fuels sold commercially, it may be advisable to advance or retard the spark slightly to take advantage of the particular fuel being used. Note the position of the octane selector scale (fig. 67), then loosen the clamp bolt and move the distributor

assembly toward Advance or Retard as desired and tighten the clamp bolt securely. By adjusting the spark in this manner it can be readjusted to the original setting when desired without special ignition timing equipment. The use of "Premium" grades of gasoline in your Corvette engine is recommended.

FUEL PUMP

A vacuum fuel pump (fig. 68) is mounted on the right side of the engine and is operated by an eccentric on the engine camshaft. It pumps fuel from the 17 gal. fuel tank and delivers it to the carburetors. The built-in vacuum pump feature assures continuous operation of windshield wipers even under sustained pulling at full throttle.

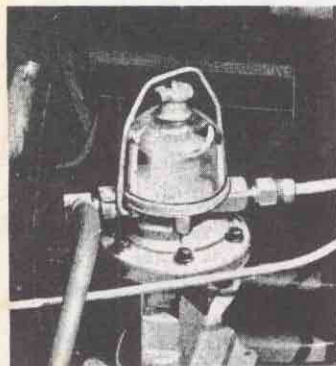

Fig. 68—Fuel and Vacuum Pump

The fuel pump to engine attaching bolts and the glass bowl retaining nut should be kept properly tightened. The glass bowl permits visual inspection to determine the amount of sediment or water in the fuel pump. When sediment or water is visible in the bowl, it should be removed from the pump and cleaned as follows:

1. Loosen the glass bowl retaining nut and remove glass bowl and screen and clean.
2. Remove gasket and clean all dirt and water from pump and gasket seat.
3. Install new gasket and the bowl.
4. Tighten bowl retaining nut securely.
5. Start engine and run until fuel pump bowl fills with gasoline, then check for leaks.

FUEL FILTER



Fig. 69—Fuel Filter

A fuel filter (fig. 69) is provided as standard equipment in the Corvette. This filter should be checked if fuel system trouble is encountered and the filter element replaced if necessary. To remove filter element, loosen glass bowl retaining nut and remove glass bowl, spring, filter element, and gasket. Clean gasket seat and install new gasket before assembling.

CARBURETOR ADJUSTMENTS

NOTE: When making these adjustments, it is necessary that the two air cleaners and breather are in-

stalled; also that the filter element of the cleaners and air screen of breather are free of any accumulation of foreign material. This is important, otherwise, mixture distribution will be affected. The two air cleaners and duct assembly are shown removed in (fig. 70) for illustrative purposes.

1. With the ignition off, loosen the three throttle lever shaft adjusting screws "A" so there is no tension on the springs.

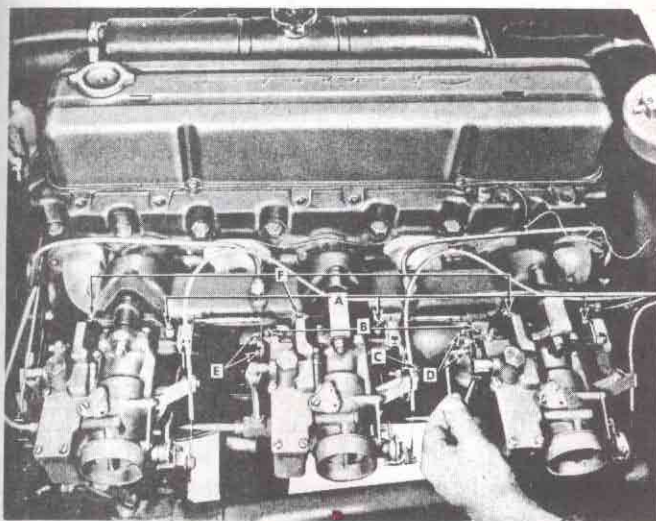

Fig. 70—Carburetor Adjustments

2. Loosen the screws "B" on the carburetor shaft universal couplings located at the forward end of the rear carburetor and the forward end of the center carburetor.
3. Snap accelerator pedal linkage "C" several times to allow the couplings to seek their natural position so there is no end pressure on the throttle valves, then tighten the two coupling screws "B".
4. Loosen the two Allen head screws "D" at the front end of the rear carburetor and manually close the throttle valve in rear carburetor. Hold valve tightly closed and tighten the two Allen head screws "D".
5. Loosen the two Allen head screws "E" at front end of center carburetor and manually close throttle valve of front carburetor. Hold valve tightly closed and tighten the two Allen head screws "E".
6. Turn the center carburetor throttle shaft adjusting screw "A" all the way in then back it off approximately 2 turns.
7. Turn the idle mixture adjustment screws "F" on each carburetor all the way in, lightly contacting the seat, then back off 1 full turn.

CAUTION: To prevent scoring or grooving of the adjusting screw needles, do not turn screws in too tightly.

8. Start the engine and run it until it is thoroughly warmed up. Make sure that the hand choke control

7. Turn the *center* carburetor throttle valve adjusting screw "B" until the engine is running 475 RPM on the tachometer.
8. Turn the *rear* carburetor idle mixture adjusting screw "A" $\frac{1}{8}$ turn right or left, to obtain maximum RPM.
9. Repeat Step 9 on the *center* and *front* carburetors.
10. If idle RPM has now changed, then turn the *center* carburetor throttle valve adjusting screw "B" until the engine is again running at 475 RPM.
11. Repeat steps 9, 10 and 11. These adjustments may have to be repeated several times to obtain proper idle RPM and idle mixture adjustment.

TRANSMISSION

The Corvette Powerglide transmission is an automatic hydraulic three element torque converter with planetary gears for reverse and low. It is essentially the same as the 1954 Chevrolet passenger car Powerglide with automatic shift features. No oil cooler is required with the transmission as the high engine torque available, coupled with the lesser demands made for torque converter multiplication with this light weight car, makes the use of an oil cooler unnecessary.

COOLING SYSTEM

The cooling system is designed with two purposes in mind; first, to carry off a certain amount of heat created in the engine so it will not operate at too high a temperature; and second, to maintain the engine heat at the temperature which will produce the most efficient and economical operation of the engine.

The cooling system consists of radiator with auxiliary tank, fan, water pump, thermostat, water passages in cylinder block and cylinder head, and the necessary connections and fittings.

An auxiliary tank with a four pound pressure cap is located on the upper right side of the engine slightly above the top of the cylinder head. This tank retains a reserve supply of water to keep the cooling system filled. When the cooling system requires water, it is added through the auxiliary tank filler opening as there is no opening in the radiator top tank. A vapor line connects the radiator top tank to the auxiliary tank to vent air or vapor from the radiator to the auxiliary tank where it can escape through the pressure cap. This vapor line cannot be bent so as to create a sag as water or vapor may accumulate in this pocket and prevent the transfer of air. The overflow line is attached to the filler neck and drains at the front of the engine.

The 18 inch fan which is driven by a V-type belt at 9/10ths engine speed, assures a constant flow of air through the radiator and around the engine to aid in cooling the water. The permanently lubricated centrifugal type water pump keeps the water circulating thereby constantly bringing cooler water to the areas around the combustion and exhaust chambers where most heat is generated. The thermostat restricts the flow of water to the radiator until the engine warms up to normal operating temperature.

CHANGING TO ANTI-FREEZE

In selecting an anti-freeze solution for winter operation, the local conditions and the type of service must be considered. In any event it is very essential to make certain checks and do certain things to at least insure the anti-freeze remaining in the cooling system. To be certain that the solution will not leak out and be lost entirely, resulting in little or no protection against freezing, or seep into the working parts of the engine, the following procedure should be followed in conditioning the system:

1. Drain the entire cooling system including the cylinder block. If considerable rust, scale, oil, or grease is present in the water drained out, it is advisable to flush and clean the system.
2. Tighten all cylinder head bolts in sequence as described on page 41. Anti-freeze or water, mixed with engine

oil may form sludge which will interfere with lubrication and in some cases may form varnish-like deposits which will cause gumming and sticking of the moving parts.

NOTE: Tightening cylinder head bolts may decrease valve clearance. Check and adjust valves if necessary (See Valve Adjustment, page 41).

3. Inspect the fan belt and adjust or replace if necessary (See Fan Belt Adjustment, page.49).
4. Inspect all hoses including heater hoses. If hoses are collapsed, cracked or in any way indicate a rotted condition on the inside, replacement should be made. Carefully check and tighten all hose clamps.

NOTE: Make sure that the vapor line connecting the radiator top tank to the auxiliary tank does not sag between ends so as to permit water or vapor to accumulate in this pocket and prevent the transfer of air.

5. Check the thermostat. Make sure it does not stick open or closed. The standard thermostat is rated at 145°. A 181° thermostat should be installed when permanent anti-freeze is used.
6. Fill the cooling system with the proper quantity of anti-freeze and water according to the instructions of the

anti-freeze manufacturer. Allow additional amount of anti-freeze for car heater.

7. Warm up engine and check radiator, auxiliary tank, water pump, hoses and hose connections for leaks with engine hot.

CARE AND MAINTENANCE

The cooling system must be kept in good condition if it is to cool the engine properly under all operating conditions. The cooling system should be kept clean. Use only rust-inhibiting anti-freeze solutions, following the manufacturer's specification. When plain water is used as a coolant, it is recommended that a rust inhibitor be added to the coolant. Since the action of the cooling system controls the operating temperature of the engine, it is essential that systematic inspection of units in the system be made periodically to maintain the efficiency of the system.

The radiator auxiliary tank cap should be removed and the coolant level checked frequently. If the coolant level is low, water or anti-freeze should be added.

NOTE: Since the volume of solution in the cooling system expands when heated, the cooling system should be left from one pint to one quart low if filled cold, especially when anti-freeze is used, to prevent loss

of solution through the radiator auxiliary tank overflow pipe.

The vapor line between the radiator auxiliary tank and the radiator top tank should be checked regularly to see that it is not bent or sagging between the ends of the line. This vapor line vents air or vapor from the radiator to the radiator auxiliary tank where it can escape through the pressure cap. A bent or sagging line may accumulate water or vapor in a pocket and prevent the transfer of air.

The system should be thoroughly checked for leaks and all hose clamps tightened occasionally.

Twice a year the radiator and cylinder block drain cocks should be opened, all coolant removed and the system thoroughly flushed.

The front of the radiator core should be checked occasionally for bugs, leaves, etc., which would restrict air circulation. These can be flushed out from the back side of the radiator with an ordinary water hose and city water pressure.

The fan belt tension should be checked occasionally and if necessary, adjusted.

The cooling system should be checked during periods of sub-freezing temperatures to determine if the system contains adequate amounts of anti-freeze.

FAN BELT ADJUSTMENT

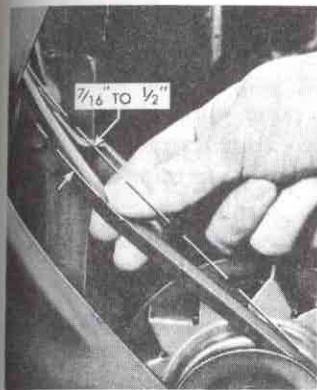

Fig. 71—Fan Belt Adjustment

1. Loosen bolt at generator slotted bracket.
2. Pull generator away from engine until desired belt tension is obtained. With correct adjustment a light pressure on the belt at a point midway between pulleys should cause a $7/16''$ to $1/2''$ deflection (fig. 71).
3. Tighten all generator bolts securely.

THERMOSTAT

The thermostat consists of a restriction valve actuated by a thermostatic element. This unit is mounted in the housing at the cylinder head water outlet above the water pump.

Thermostats are designed to open and close at predetermined temperatures and if not operating properly may cause abnormally high or abnormally low engine temperatures. If the condition of the thermostat is questioned, it can be removed and tested as follows:

1. Open radiator drain cock and drain out about half the

coolant to bring the coolant level below the thermostat, then close the drain cock.

2. Remove the two cap screws that attach the water outlet to the thermostat housing (fig. 72) and lift water outlet (with hose attached), gasket, and thermostat from housing.
3. Heat a container of water to a temperature 25° above the temperature stamped on the thermostat and place thermostat in the water and see if it opens fully. If it does not fully open, it should be replaced.



Fig. 72—Thermostat Housing

4. Place thermostat in water 10° below the temperature stamped on the thermostat and see if thermostat fully closes. If it does not fully close, it should be replaced.
5. Place thermostat in housing, then using a new gasket, install water outlet and cap screws. Tighten screws evenly and securely.

6. Fill cooling system and check it for leaks.

CLEANING THE COOLING SYSTEM

Unless water in the cooling system is treated with a corrosion preventative, rust and scale may eventually clog water passages in the radiator and water jackets. This rust accumulation will result in inefficient operation of the cooling system, vitally affecting engine performance and economy of operation. Two common causes of corrosion are:

1. Air Suction—Air may be drawn into the system due to low liquid level in the radiator, leaky water pump, or loose hose connection.
2. Exhaust Gas Leakage—exhaust gas may be blown into the cooling system past the cylinder head gasket or through cracks in the cylinder head and block.

Scale and deposits in the cooling system which will not flush out can generally be removed by using a good cooling system cleaning compound. When using a cleaning compound in the cooling system it is advisable to follow the instructions furnished with the particular brand of compound.

If cooling system cleaning compound will not thoroughly clean the system, it is advisable to reverse-flush the system. See your Chevrolet dealer regarding reverse-flushing of your Corvette cooling system.

TESTING THE ANTI-FREEZE

A hydrometer test is used to indicate whether anti-freeze, or water or both should be added to bring the solution to the proper level and to maintain the desired freezing point. Some devices used for testing anti-freezing solutions will indicate the correct freezing point only when the test is made at a specific temperature. Other testers provided with thermometers and tables, indicate the freezing points corresponding to readings made at various temperatures. Disregarding the temperature of the solution when tested may cause an error as large as 30° F.

Some testing devices are made to test only one kind of anti-freezing solution. Others have several scales and may be used for the corresponding kinds of anti-freeze.

ELECTRICAL SYSTEM

The electrical system consists of the following units—generator, combined voltage and current regulator, starting motor, storage battery, distributor, ignition lock, ignition coil, ammeter, gasoline gauge, horn, accessories, lamps, switches, wiring and miscellaneous parts. The electrical system utilizes metal shields, coaxial condensers, shielded wiring, non-metallic high tension cables, and shielded neutral safety switch at the transmission, to prevent radiation of radio frequency interference from the plastic body.

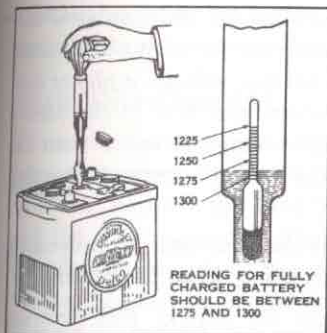

Fig. 73—Testing Battery Specific Gravity

BATTERY

A 6 volt, 15 plate, 100 ampere-hour storage battery is located under the hood on the right side of the frame. To assure long carefree battery service, the level of the solution in each cell should be checked at least once in two weeks. Remove filler caps from all three cells and add distilled water to bring solu-

tion $\frac{1}{4}$ " above the plates in each cell, then reinstall and tighten filler caps. In freezing weather the vehicle must be driven after adding water to mix it properly with the electrolyte and prevent freezing. It is also important to keep the battery in a fully charged condition in cold weather as a discharged battery will freeze at a little below the freezing point of water (32° F.).

The state of charge in the battery should be checked regularly. Your Chevrolet dealer will gladly perform this service. However, if it is inconvenient to take your Corvette to a dealer, the state of charge in the battery can be checked by using a battery hydrometer (fig. 73). A fully charged battery should have a specific gravity of 1.275 to 1.300,

while a fully discharged battery will have a specific gravity of approximately 1.150.

CAUTION: Batteries give off highly combustible hydrogen gas when charging and for some time after. Never allow an electric spark or flame near the battery, particularly the vent caps. Before working around battery, ground the car to reduce the possibility of static spark. Avoid getting battery acid on car finish, clothing or other fabrics.

The battery cable terminals must be kept clean and tight. Loose or corroded terminals cause hard starting and discharged batteries. When corrosion appears on the terminals, they should be cleaned in a solution of baking soda and water or ammonia and water. After cleaning, the top of the battery should be flushed off with clear water. To reduce the tendency of the terminals to corrode, coat them with petrolatum.

IGNITION SYSTEM

The ignition system consists of the ignition switch to open and close the circuit, the coil to induce high voltage, the distributor to make and break the low tension circuit and distribute the high tension current to the correct spark plugs, the spark plugs to provide the spark in the combustion chamber and the necessary wiring. The battery is the

source of current for the ignition system when starting the engine or operating at idling speed. The generator furnishes the ignition current at higher speeds.

The distributor mounting provides a means of properly setting the initial ignition timing. The spark advance for various speeds and loads is controlled automatically by governor weights and vacuum control in the distributor.

The octane selector at the rear of the distributor mounting provides a means of advancing or retarding the ignition timing for the grade of fuel being used.

The battery and generating system must be kept in good operating condition in order to obtain satisfactory operation of the ignition system. All wiring connections in the ignition circuit should be kept tight and free from dirt and corrosion. Keep the high tension wires free from grease and tight in the distributor cap and coil.

GENERATING SYSTEM

The generating system consists of the generator, voltage and current regulator, ammeter and necessary wiring.

The ammeter indicates whether current is being supplied to or removed from the battery.

The generator has sufficient capacity to supply all regularly used accessories and keep the battery fully charged providing the system is in good condition.

The generator output is controlled by the combined current and voltage regulator and cutout relay. The cutout relay points close when the generator voltage is higher than the battery voltage so that current can flow to the battery and open when the generator voltage is lower than the battery voltage to prevent the battery from discharging through the generator.

The current regulator protects the generator by preventing the generator output from exceeding 45 to 51 amperes.

The voltage regulator protects the battery and electrical system by preventing the generator voltage from exceeding 7.0 to 7.7 volts.

The cutout relay points open at 0-4 amperes and close at 6.4 volts.

The connections in the entire generating circuit must be kept tight and free from corrosion or anything that will cause high resistance in the circuit. The generator should be lubricated as described on page 60.

The maintenance of the generating system, especially the voltage and current regulator, require the use of special equipment not generally available to the vehicle owner. At periodic intervals of approximately 5000 miles, the terminals, external connections and wiring, mounting, belt and pulley should be checked. The commutator and brush inspection can be made through the openings in the commutator end frame. If the commutator is dirty or if the

brushes are badly worn, it is best to have your Chevrolet dealer make the necessary test and repairs.

STARTING SYSTEM

The starting system has only one function to perform—to crank the engine. In the starting system there are four basic units: the battery, the starting solenoid, the starting relay, and the starting motor. The battery supplies the energy, the solenoid completes the circuit, allowing this energy to flow to the starting motor and the relay is used with the solenoid to reduce the voltage drop during the starting operation. The motor which draws a large amount of current for a short period of time, then delivers mechanical energy and does the actual work of cranking the engine. The motor is designed to incorporate a solenoid drive mechanism which assures positive engagement of the starting motor pinion with the flywheel until the engine is started. The solenoid is controlled by the key starter switch in the battery circuit. A shielded neutral safety switch is provided to prevent starting of the engine with the transmission selector lever in other than "P" or "N" position. The starter solenoid should be lubricated as described on page 61.

HEADLAMPS AND SCREENS

The Corvette is equipped with "Sealed Beam" headlight units in which the light source, the reflector, lens and gasket

are all assembled in a securely sealed unit. This sealed construction prevents tarnished reflectors and keeps dirt and moisture from the reflector and inside of lens, assuring maximum lighting efficiency throughout the life of the unit. The "Sealed Beam" units have two separate filaments located in the unit in position to produce an upper (country) light beam and a lower (traffic) light beam. The upper beam is designed to illuminate the road evenly for considerable distance ahead of the vehicle and should only be used on the open highway when no other vehicles are approaching. The lower beam is adjusted to illuminate the right side of the road a reasonable distance ahead but to prevent glare in the eyes of the oncoming drivers. When the



Fig. 74—Headlamp and Screen

upper beams are in use, a red pilot light will be seen through a small opening in the speedometer dial. The dimmer switch is used to switch from one beam to the other. A wire protector screen, rim and housing assembly (fig. 74), which is hinged at the top and secured with a single screw at the bottom, is provided to cover the headlight opening in the fender.

NOTE: Some State Laws prohibit the use of these screens. Where in doubt, consult your Chevrolet dealer who will advise you regarding this matter. The screen may be removed, if necessary, as described on pages 19 and 20.

HEADLAMP REPLACEMENT AND ADJUSTMENT



Fig. 75—Removing Rim, Screen and Housing

1. Remove single screw at bottom of chrome rim surrounding headlight opening (fig. 74) lift rim, screen, and housing assembly (fig. 75) and remove from opening.
2. Remove the three screws holding the sealed beam retaining ring (fig. 76). Do not disturb the headlamp adjusting screws on top and left side of unit.
3. Rotate retaining ring counter-clockwise and remove ring (fig. 77).
4. Pull sealed beam unit forward and disconnect wiring plug from sealed beam unit.

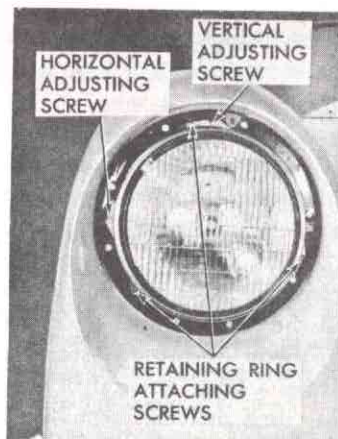

Fig. 76—Sealed Beam Installation

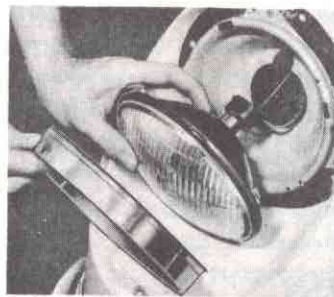

Fig. 77—Removing Retaining Ring and Sealed Beam Unit

5. Connect wiring plug to new sealed beam unit, place retaining ring around unit, push the assembly into place and install the three attaching screws.
6. Install the rim, screen, and housing assembly and secure in place with single screw.

Adjustment

Two screws are provided for vertical and horizontal adjustment of the beam as shown (fig. 76). Turning the vertical adjusting screw "In" or "Out" will raise or lower the light beam, while turning the horizontal adjusting screw "In" or "Out" will move the light beam laterally to the right or left.

Proper aiming of these

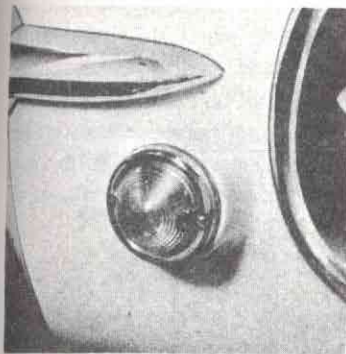

Fig. 78—Parking and Direction Signal Lamp

powerful lights is most important to assure sufficient illumination of the highway without blinding other motorists. To obtain maximum results in road illumination and in the safety that has been built into the headlighting equipment, your Chevrolet dealer, who has special equipment for the purpose, should be contacted whenever light aiming is necessary.

PARKING AND TAIL LAMPS

Combination parking and direction signal lamps are located at the front end of the car between the lower front fender and the grill (fig. 78) while combination tail, stop and direction signal lamps are located in the tail light assemblies on

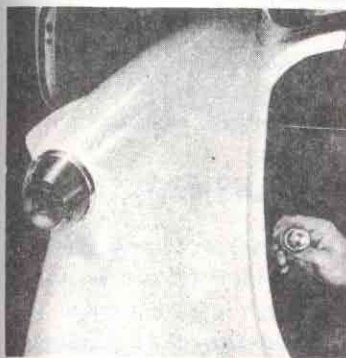

Fig. 79—Tail Lamp Bulb Removal

the rear fenders. Each tail lamp bulb and socket assembly is retained by a spring clip and is removed from inside the luggage compartment by pulling the bulb and socket assembly out of the lamp body (fig. 79). Access to each parking lamp is gained by removing the cover screws and cover from outside the body.

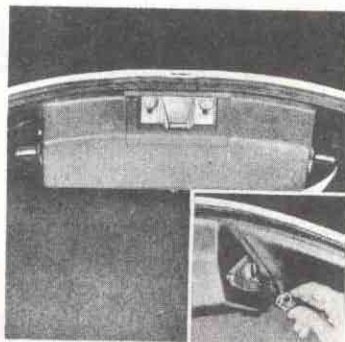

Fig. 80—License Plate Lamp Bulb Removal

LICENSE PLATE LAMPS

Two license plate lamps are located in the license plate compartment in the luggage compartment lid. Access to these lamps is gained by raising the luggage compartment lid to expose the lamp assemblies installed to the sides of the license plate compartment (fig. 80). Each lamp assembly

is retained by a spring clip and can be removed by pulling out to release clip (see inset, fig. 80).

CIRCUIT BREAKER

The lighting switch controlling instrument panel and exterior lights incorporates a 30 ampere thermal circuit breaker

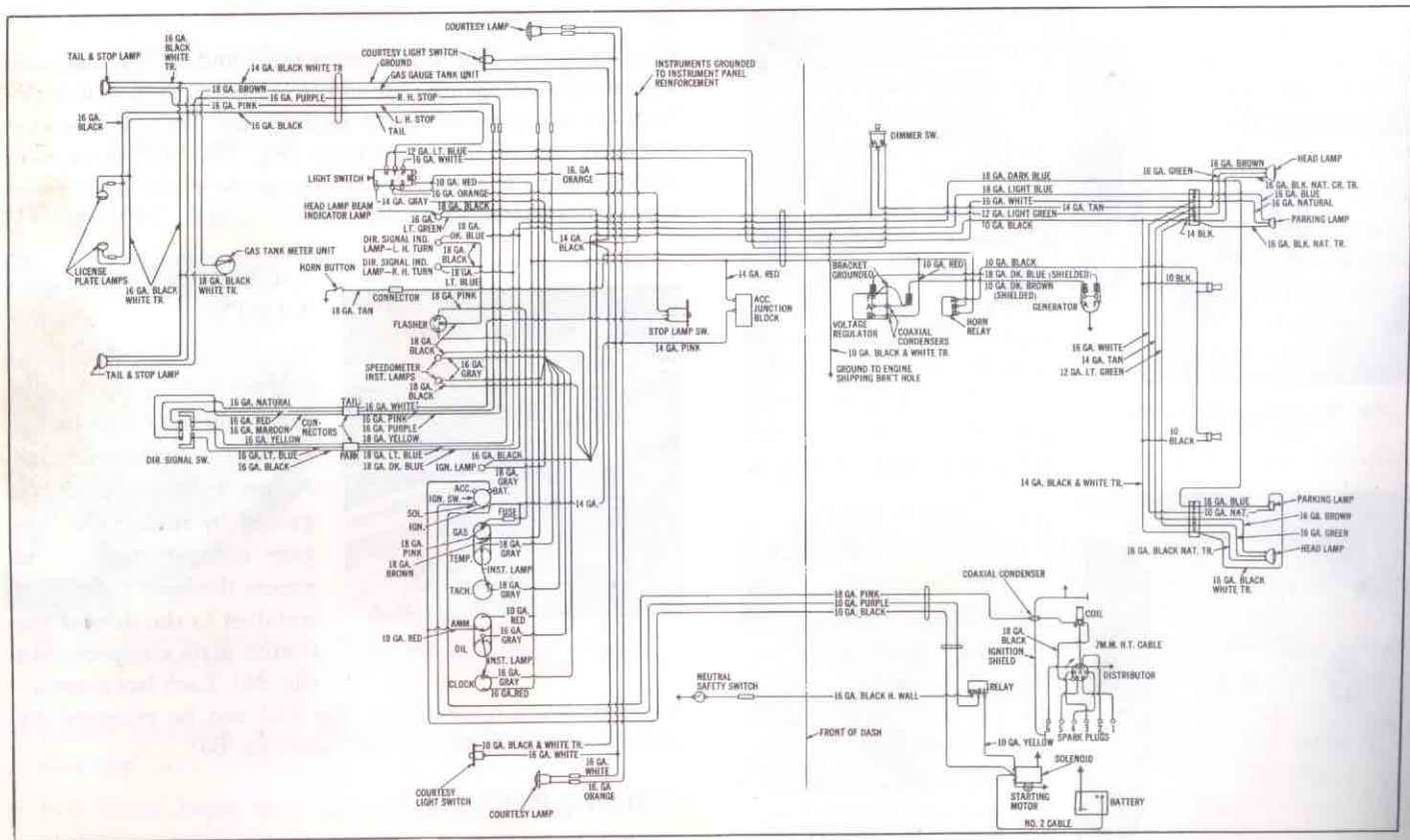

Fig. 81—Wiring Diagram

to protect the lighting system exclusive of accessories. Separate safety fuses are provided for radio, heater, direction signal and parking brake alarm. If an overload or short circuit occurs in the lighting system, causing a current flow of more than 30 amperes, the points of the circuit breaker will open and close as they warm and cool until the short is located and corrected.

FUEL TANK

A 17 gallon fuel tank is strapped into the body in a bulkhead located behind the seats and under the top compartment (fig. 56). It is cushioned and completely sealed in this compartment with ventilation provided by large holes in the underbody. The filler neck is attached to the tank by rubber hose connection. Access to the fuel tank and upper rear shock absorber attaching points can be gained by removing the plastic cover in the bottom of the folding top compartment as described on page 33.

GENERAL LUBRICATION

The selection of the proper lubricant and its correct application at regular intervals does much to increase the life and operation of all moving parts of the vehicle. Consequently, it is important that the correct grade of oil or grease, as described on the following pages, be used.

ENGINE LUBRICATION

Proper selection of the engine oil to be used will add much to the performance, reliability, economy and long life of the engine. It is imperative that the "breaking-in" oil in the crankcase of your new Corvette at delivery be used for the first 500 miles. Light oils contribute toward a better breaking in of the engine as they assure ease of starting, prompt flow of a sufficient quantity of oil to the bearings, less friction between moving parts, less wear of moving parts, etc.

Temperature Considerations

During the colder months of the year, an oil which will permit easy starting at the lowest atmospheric temperature likely to be encountered should be used. When the crankcase is drained and refilled, the crankcase oil should be selected, not on the basis of the existing temperature at the time of the change, but on the lowest temperature anticipated for the period during which the oil is to be used. Unless the crankcase oil is selected on the basis of anticipated temperature, difficulty in starting will be experienced at each sudden drop in temperature. See page 23 for recommended lubricants to use in the crankcase of your Corvette engine for each anticipated temperature range.

When to Change Crankcase Oil

Oils have been greatly improved, driving conditions have

changed, and improvements in engines, such as the crankcase ventilating system have greatly lengthened the life of good lubricating oils. However, to insure continuation of best performance, low maintenance cost and long engine life, it is necessary to change the crankcase oil whenever it becomes contaminated with harmful foreign materials. Under normal driving conditions draining the crankcase and refilling with fresh oil every 2000 to 3000 miles is recommended.

Frequent long runs at high speed, with resultant high engine operating temperatures, may oxidize the oil and may result in the formation of sludge and varnish. While no definite drain periods can be recommended, under these conditions, they should be more frequent than under normal driving conditions.

Driving over dusty roads or through dust storms introduces abrasive material into the engine. The frequency of draining depends on severity of dust conditions and no definite draining periods can be recommended but should be more frequent than under normal driving conditions.

Short runs in cold weather, such as city driving and excessive idling, do not permit thorough warming up of the engine and water may accumulate in the crankcase from condensation of moisture produced by the burning of the fuel. Water in the crankcase may freeze and interfere with

proper oil circulation. It also promotes rusting and may cause clogging of oil screens and passages. Under normal driving conditions this water is removed in the form of vapor by the crankcase ventilator. However, if water accumulates, it should be removed by draining the crankcase as frequently as may be required. It is always advisable to drain the crankcase only after the engine has become thoroughly warmed up or reached normal operating temperature. The benefit of draining is, to a large extent, lost if the crankcase is drained when the engine is cold, as some of the suspended foreign material will cling to the sides of the oil pan and will not drain out readily with the cold, slower moving oil. Flushing the crankcase with oils or solutions other than a good grade of SAE 10W engine oil is not recommended.

Maintaining Oil Level

The oil gauge rod is marked "Full" and "Add Oil." These notations have broad arrows pointing to the level lines. The oil level should be maintained between the two lines, neither going above the "Full" line nor under the "Add Oil" line.

Check the oil level frequently and add oil when necessary. Always be sure the crankcase is full before starting out on a long drive.

Crankcase Dilution

Probably the most serious phase of engine oil deterioration

is that of crankcase dilution, which is the thinning of the oil by fuel vapor leaking by pistons and rings and mixing with the oil. Leakage of fuel or fuel vapors into the oil pan mostly occurs during the "warming up" period when the fuel is not thoroughly vaporized and burned.

Automatic Control Devices to Minimize Crankcase Dilution

The Corvette engine is equipped with automatic devices which aid greatly in minimizing the danger of crankcase dilution.

Rapid warming up of the engine is aided by the thermostatic water temperature control which automatically prevents circulation of coolant through the radiator until it reaches a pre-determined temperature.

When operative, the thermostatic heat control on the exhaust manifold during the warming up period automatically directs the hot exhaust gases against the center of the intake manifold, greatly aiding in proper vaporization of the fuel. See page 38 for further information on the manifold heat control valve in your Corvette engine.

An efficient crankcase ventilating system drives off fuel vapors and aids in the evaporation of the raw fuel and water which may find its way into the oil reservoir.

Control by Car Owners Under Abnormal Conditions

Ordinarily the above automatic control devices will minimize or eliminate the danger of crankcase dilution. However, there are abnormal conditions of service when the car owner must aid in the control of crankcase dilution.

Sparing use of the choke reduces danger of raw or unvaporized fuel entering the combustion chamber and leaking into the oil reservoir.

Short runs in cold weather, such as city driving and excessive idling, do not permit the thorough warming up of the engine nor the efficient operation of automatic control devices. It is recommended that the oil be changed more often when the car is subjected to this type of operation.

Poor mechanical condition of the engine such as scored cylinders, poor ring fit, sloppy or loose pistons, faulty valves, and poor ignition will increase crankcase dilution. Poor fuels which contain portions hard to ignite and slow to burn will also increase crankcase dilution.

Water in Crankcase

Serious lubrication troubles may result in cold weather by an accumulation of water in the oil pan. This condition is, as a rule, little understood by the owner. To demonstrate the chief cause of water in the oil pan, hold a piece of cold metal near the end of the exhaust pipe of the engine and

note the rapid condensation and collection of drops of water on it. The exhaust gases are charged with water vapor and the moment these gases strike a cold surface, they will condense forming drops of water. A slight amount of these gases passes the pistons and rings, even under most favorable conditions, and causes the formation of water in the oil pan until the engine becomes thoroughly warm, then the crankcase will no longer act as a condenser and all of these gases will pass out through the crankcase ventilating system. Short runs in cold weather, such as city driving, will aggravate this water forming condition.

Corrosion

Practically all present day engine fuels contain a small amount of sulphur which, in its natural form, is harmless. This sulphur, however, when it burns forms a gas, a small amount of which is likely to leak past pistons and rings and react with water when present in the oil pan to form a very corrosive acid. The more sulphur in the fuel, the greater the danger of this type of corrosion. This is a condition which cannot be wholly corrected, but it may be reduced to a minimum by proper care of the engine.

As long as the gases and internal walls of the crankcase are hot enough to keep water vapor from condensing, no harm will result. However, when the engine is run in low temperatures, moisture will collect and unite with the gases formed by combustion resulting in an acid formation. The

acid thus formed is likely to cause serious etching or pitting which will manifest itself in excessively rapid wear on piston pins, camshaft bearings and other moving parts of the engine, oftentimes causing the owner to blame the car manufacturer or the lubricating oil, when in reality the trouble may be traced back to the character of fuel used, or a condition of the engine such as excessive blowby or improper carburetor adjustment.

WATER PUMP

The water pump is of the ball bearing type, lubricated at the time of manufacture and permanently sealed. This type of pump requires no further lubrication.

GENERATOR

Every 1000 miles fill cups at both ends of the generator with SAE 20 oil. If the oil in the commutator end bearing (rear oiler) becomes completely exhausted through failure to lubricate at regular intervals, it will require more than a single filling to restore the oil reserve in this oiler. In such cases, fill the oil cup three times consecutively, allowing sufficient time between fillings to permit the oil to drain down.

NOTE: The successive refilling of the oiler should only be performed at the rear oiler. Successive fillings should never be made at the front oiler. Over-oiling at the front oiler may result in damage to the generator.

DISTRIBUTOR

The distributor is equipped with a lubrication cup. Fill this cup with chassis lubricant and turn down one turn every 1000 miles. The distributor cap should be removed every 5000 miles, then remove rotor and apply a small amount of petroleum jelly on distributor cam surface by holding a clean cloth soaked in jelly against it while cranking starter.

STARTING MOTOR

Starting motor end frames are equipped with oil-less bearings which do not require lubricant.

STARTER SOLENOID

A few drops of engine oil should be used on the pivots of the starter shift lever mechanism. Do not oil solenoid plunger.

REAR AXLE

Since the rear axle operates under the most severe lubrication conditions at high speeds, a gear lubricant is required that will satisfactorily lubricate hypoid rear axles. Such lubricants have been developed and are commonly referred to as "Multi-Purpose" gear lubricants.

"Multi-Purpose" gear lubricants must be carefully compounded, of the latest non-corrosive type and of proven

quality. The lubricant manufacturer must be responsible for the satisfactory performance of his product. His reputation is the best indication of quality.

It is recommended that S.A.E. 90 "Multi-Purpose" gear lubricant be used in the Corvette rear axle.

CAUTION: *Do not use Straight Mineral Oil gear lubricants in the rear axle.*

When checking lubricant level, the unit being checked should be at operating temperature. With unit at operating temperature the lubricant should be level with bottom of the filler plug hole. If the lubricant is checked with the unit cold, the lubricant level should be $\frac{1}{2}$ inch below the filler plug hole.

Normally, seasonal changes of the rear axle lubricant are not required but may be advisable in vehicles subject to severe service. When draining use a light flushing oil to flush out the housing.

CAUTION: Do not use water, steam, kerosene, gasoline or alcohol to flush units.

TRANSMISSION

"Automatic Transmission Fluid Type A" bearing an AQ-ATF number should be used in the Powerglide Transmission.

Check oil level every 1000 miles with engine idling, parking brake set, transmission warm and control lever in "N"

position. Add fluid when level reaches "Add 1 qt." mark on oil level rod located on right side of engine. Do not allow dirt to enter filler tube.

Every 25,000 miles the transmission sump should be drained and refilled. Flushing should not be performed on the Powerglide transmission. Before draining warm up transmission, then remove drain plug from transmission case. After draining, replace plug and refill with four quarts of "Automatic Transmission Fluid Type A." Idle the engine in neutral with hand brake set. After a few moments check oil level and if necessary, add enough oil to bring it up to the full mark on the dip stick.

UNIVERSAL JOINTS

Propeller shaft universal joints are permanently lubricated and do not require any further lubrication.

FRONT WHEEL BEARINGS

It is necessary to remove the wheel and hub assembly to lubricate the bearings. The bearing assemblies should be cleaned before repacking with lubricant. Do not pack the hub between the inner and outer bearing assemblies or the hub caps as this excessive lubrication results in the lubricant working out into the brake drums and linings. The front wheels are equipped with ball bearings and should be

packed with a high melting point front wheel bearing lubricant. The front wheel bearings should be cleaned and repacked and adjusted every 10,000 miles. See also "Front Wheel Bearings—Adjust" on page 31.

REAR WHEEL BEARINGS

The rear wheel bearings receive their lubrication from the rear axle. When installing bearings which have been cleaned, repack with smooth type grease.

SPRING SHACKLES

The spring shackles used at the rear end of the rear chassis springs are the rubber bushed type. Rubber bushings are also used at the front of each rear spring.

These bushings must not be lubricated or sprayed with oil.

BRAKE PEDAL

This pedal, lubricated at the time of assembly, should not require further lubrication.

STEERING GEAR

The steering gear is filled at the factory with a special all-season gear lubricant. Seasonal change of this lubricant is unnecessary and the housing should not be drained. When-

ever required, additions should be made using a lubricant which at low temperatures, is fluid and will not "channel" or cause "hard steering" and which will provide satisfactory lubrication under extreme summer conditions. Steering gear lubricants are marketed by many oil companies and either "Multi-Purpose" or "Universal" gear lubricants are satisfactory to use.

The pipe plug is installed in its particular location in the steering gear housing to prevent overlubrication, generally occasioned by the use of a pressure gun. Overlubrication of this unit might result in forcing lubricant up the steering gear tube to the horn button and steering wheel.

SHOCK ABSORBER

The shock absorbers, front and rear, used on the Corvette are permanently sealed and require no maintenance other than replacement if necessary.

CHASSIS LUBRICATION

For chassis lubrication, consult the lubrication chart and diagram, pages 24-25, which show the points to be lubricated and how often the lubricant should be applied. The term "chassis lubricant" as used in this manual describes a semi-fluid lubricant designed for application by commercial pressure gun equipment. It is composed of mineral oil combined with approximately 8% soap, for soaps which are insoluble in water.

Body Lubrication

The movable mechanical parts of the body are lubricated at the factory for easy operation and to eliminate squeaks caused by frictional contact. This lubrication should be maintained and replenished at periodic intervals.

Most body lubrication points do not carry heavy loads like the chassis, and for this reason many of the points do not require as heavy nor as frequent lubrication as the chassis points.

For body lubrication, a specific kind of lubricant, the one best suited for individual points, should be used. Knowing what to use and where to use it, together with a little care and cleanliness, will bring many returns in the satisfaction and pleasure of driving a car properly serviced.

For exposed surfaces, such as door checks and engaging surfaces of locks, striker plates, dovetail bumper wedges, etc., apply a thin film of light engine oil.

The seat adjusters and seat track, ordinarily overlooked, should be lubricated with cup grease, graphite grease, or dripless oil—used sparingly.

Lubricate only where squeaks develop or where conditions indicate that the addition of lubricant is desirable for easier operation of individual units or points. Too much lubrication applied to exposed parts increases the possibility of soiling clothing that may brush against the lubricated part.

DIMENSIONS

Wheelbase.....	102"
Length (Overall).....	167"
Width (Overall).....	72.24"
Height (Over Windshield—Top Down).....	48.5"
Tread: Front.....	57"
Rear.....	59"
Turning Diameter.....	38'

CAPACITIES

Fuel Tank.....	17 $\frac{1}{4}$ Gal.
Crankcase.....	5 Qt.
Cooling System	
Without Heater.....	17 $\frac{3}{4}$ Qt.
With Heater.....	18 $\frac{1}{4}$ Qt.
Transmission: Total.....	11 Qt.
Sump Refill.....	4 Qt.
Rear Axle.....	3 $\frac{1}{2}$ Pt.

GENERAL SERVICE DATA

Engine Idling Speed.....	475 (In Drive)
Valve Clearance: Intake (Hot)....	.010"
Exhaust (Hot)...	.020"
Spark Plug Gap.....	.035"
Wheel Alignment: Caster.....	0°—1°
Camber.....	0°—1°
Toe-in.....	0— $\frac{1}{8}$ "

Distributor: Point Gap (Used).....	.016"
Point Gap (New).....	.019"
Breaker Arm Tension..	19—23 oz.

Distributor points to break when steel ball in flywheel is in line with pointer on flywheel housing.

Brake shoe clearance adjustment—to light drag and back off 7 notches.

Fan Belt adjusted to $\frac{1}{16}$ " to $\frac{1}{2}$ " deflection with light pressure on belt at a point midway between pulleys.

LAMP BULB DATA

<i>Location</i>	<i>Candle Power</i>	<i>Number</i>
Headlamp	45-35 (Watts)	Sealed Beam
Headlamp Beam Indicator	1	51
Parking and Dir. Signal	3—21	1154
Tail and Stop-Dir. Signal	3—21	1154
Parking Brake Alarm		
Lamp	6	82
License Plate Lamp	3	63
Instruments	2	55
Direction Signal Indicator (Speedometer)	1	51
Electric Clock	2	55
Courtesy Lamp	6	82
Radio Dial	2	52
Cigarette Lighter	1	51
Ignition Switch	1	51

FUSE DATA

Fuses	Capacity	Location
Direction Signal	14 AMP	End of lead at gasoline gauge terminal
Radio	14 AMP	End of lead at accessory junction block
Heater	14 AMP	End of lead at accessory junction block
Parking Brake Alarm	14 AMP	End of lead at accessory junction block

THERMAL CIRCUIT BREAKER—The thermal circuit breaker, which is located in the lighting switch, protects all lamps in car except those incorporating fuses. When current load is too heavy, such as encountered in shorts, the circuit breaker opens and closes rapidly, reducing current sufficiently to protect wiring until cause is eliminated.

MANUFACTURER'S WARRANTY

It is expressly agreed that there are no warranties, expressed or implied, made by either the Dealer or the Manufacturer on Chevrolet motor vehicles, chassis or parts furnished hereunder, except the Manufacturer's warranty against defective materials or workmanship as follows:

"The Manufacturer warrants each new motor vehicle, including all equipment or accessories (except tires) supplied by the Manufacturer, chassis or part manufactured by it to be free from

defects in material and workmanship under normal use and service, its obligations under this warranty being limited to making good at its factory any part or parts thereof which shall within ninety (90) days after delivery of such vehicle to the original purchaser or before such vehicle has been driven 4,000 miles, whichever event shall first occur, be returned to it with transportation charges prepaid and which its examination shall disclose to its satisfaction to have been thus defective; this warranty being expressly in lieu of all other warranties, expressed or implied, and all other obligations or liabilities on its part, and it neither assumes nor authorizes any other person to assume for it any other liability in connection with the sale of its vehicles.

This warranty shall not apply to any vehicle which shall have been repaired or altered outside of an authorized Chevrolet Service Station in any way so as in the judgment of the Manufacturer to affect its stability and reliability, nor which has been subject to misuse, negligence or accident.

The Manufacturer has reserved the right to make changes in design or add any improvements on motor vehicles and chassis at any time without incurring any obligation to install same on motor vehicles and chassis previously purchased."

TIRE AND BATTERY WARRANTIES

The tires and battery furnished with your new Chevrolet carry separate warranties and should be registered with the nearest agent of the particular manufacturer. Your Chevrolet dealer will gladly assist you in this registration.

OWNER SERVICE POLICY

Upon delivery of your new Chevrolet, you received an Owner Service Policy which you should read carefully and keep with your car during the Warranty period.

Under the terms of this policy you are entitled to receive, from any Chevrolet dealer in the U.S.A. or Canada, an inspection and adjustment, on a no charge basis, if the policy coupon is presented during the first 1,500 miles of vehicle operation.

Any Chevrolet dealer in the U.S.A. or Canada is authorized to replace, without charge for material or labor, any parts found to be defective under the terms of the Chevrolet Factory Warranty.

OWNER SERVICE POLICY

Delivery . . . The Dealer will see that the vehicle is properly prepared according to Standard Factory instructions before delivery to the owner.

Use of this Policy . . . This Owner Service Policy entitles the owner to receive service in accordance with the terms hereof at all authorized Chevrolet Service Stations. This Policy should be carried in the vehicle at all times.

Installation of Parts Furnished Under Warranty . . . Parts supplied under the manufacturer's warranty (see Owner's Manual) will be installed by any Chevrolet dealer in the United States or Canada without any charge for labor.

1000-Mile Adjustment . . . The attached coupon, when signed by the authorized Chevrolet selling Dealer, entitles the owner to the inspection and adjustments listed on the back. These services are given free by any Chevrolet dealer in the United States or Canada upon surrender of the coupon.

Inspections . . . In order that your Chevrolet vehicle may provide maximum service and dependability, we suggest that you have it inspected every 30 days or 1000 miles by an authorized Chevrolet service station.

Tourist Privilege . . . Upon presentation of this Policy by the owner when touring, any authorized Chevrolet service station in the United States or Canada will perform the services as outlined in paragraphs three, four and five.

Change of Residence . . . In the event the owner moves to another location before the warranty period has expired, the authorized Chevrolet service station serving the new locality will fully honor this Policy, and will render any no-charge service due under paragraphs three, four and five.

